

CATÁLOGO  
GENERAL  
2022





ATENCIÓN AL CLIENTE  
Y POSTVENTA



SERVICIO

STOCK PERMANENTE



TRANSPORTE  
Y DISTRIBUCIÓN

REDES SOCIALES



## CATÁLOGO 2022

01. CAJONES, GUÍAS Y CUBERTEROS	04
02. PROTECTORES Y ESCURREPLATOS	28
03. PISTONES, SISTEMA DE APERTURA Y BISAGRAS	30
04. VITRINAS	48
05. ELEMENTOS LINEALES Y PERSIANAS	50
06. EQUIPAMIENTO DE COCINAS	56
07. PATAS, COLGADORES, SOPORTES, TOPES	57
08. CUBOS Y SALIDAS DE HUMOS	67
09. CESTILLERÍA	73
10. ILUMINACIÓN Y CONECTIVIDAD	85
11. INTERIORISMO DE ARMARIO	94
12. ARMARIOS	102
13. TIRADORES	105
14. ACCESORIOS ESPECIALES	122
15. TORNILLERÍA	129

CONDICIONES GENERALES DE VENTA

## 01. CAJONES, GUÍAS Y CUBERTEROS



# CAJONES METÁLICOS

### CAJÓN METÁLICO ALTURA 54 **EMB. 10 UDS.**

COLORES	50
BLANCO	CO.010155001
GRIS	CO.010155005



### CAJÓN METÁLICO ALTURA 86 **EMB. 10 UDS.**

COLORES	27	35	40	45	50
BLANCO		CO.010183501	CO.010184001	CO.010184501	CO.010185001
GRIS	CO.010182705	CO.010183505	CO.010184005	CO.010184505	CO.010185005



### CAJÓN METÁLICO ALTURA 118 **EMB. 10 UDS.**

COLORES	27	35	40	45	50
BLANCO		CO.0101113501	CO.0101114001	CO.0101114501	CO.0101115001
GRIS	CO.0101112705	CO.0101113505	CO.0101114005	CO.0101114505	CO.0101115005



### CAJÓN METÁLICO ALTURA 150 **EMB. 10 UDS.**

COLORES	27	35	40	45	50
BLANCO		CO.0101153501	CO.0101154001	CO.0101154501	CO.0101155001
GRIS	CO.0101152705	CO.0101153505	CO.0101154005	CO.0101154505	CO.0101155005



### JUEGO DE TUBOS CAJÓN METÁLICO FONDO 50 **EMB. 10 UDS.**

COLORES	REDONDO	CUADRADO
BLANCO	CO.01090201	CO.01090301
GRIS	CO.01090205	CO.01090305



CÓDIGO	DESCRIPCIÓN	EMB. 100 UDS.
CO.010904	KIT DE FRENO CAJÓN METÁLICO	

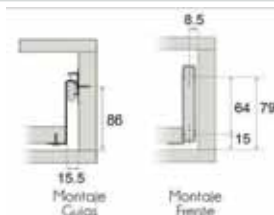
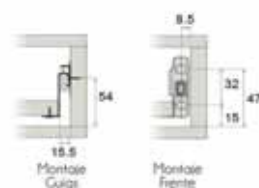
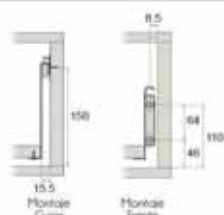
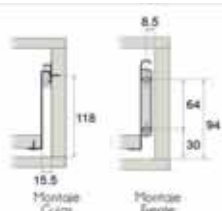

# 01. CAJONES, GUÍAS Y CUBERTEROS

## CAJONES

### CAJONES AUTOFRENO

EMB. 1 JUEGO

FONDO	27	30	35	40	45	50
AUTOFRENO	CO.0103827EI	CO.0103830EI	CO.0103835EI	CO.0103840EI	CO.0103845EI	CO.0103850EI
PUSH		CO.0103830EIP	CO.0103835EIP	CO.0103840EIP	CO.0103845EIP	CO.0103850EIP



CÓDIGO	DESCRIPCIÓN	EMB. 4 JUEGOS
E.3012705	JUEGO DE GUÍA AUTOFRENO 50KG EMUCA	

50 kg.



CÓDIGO	DESCRIPCIÓN	EMB. 8 JUEGOS
CO.0103C4	JUEGO SINCRONIZADO PARA CAJÓN PUSH	



### JUEGO VARILLAS PARA CACEROLERO

EMB. 20 JUEGOS

FONDO	27	30	35	40	45	50
REDONDA	CO.0103V27	CO.0103V30	CO.0103V35	CO.0103V40	CO.0103V45	CO.0103V50
CUADRADA	CO.0103V27C	CO.0103V30C	CO.0103V35C	CO.0103V40C	CO.0103V45C	CO.0103V50C



CÓDIGO	DESCRIPCIÓN	EMB. 20 JUEGOS
CO.0103C1	JUEGO CONECTOR TRASERA ALTURA 14	
CO.0103C2	JUEGO CONECTOR TRASERA ALTURA 20	



CÓDIGO	DESCRIPCIÓN	EMB. 4 UDS.
CO.0103C3	DISTANCIADOR LATERAL 25*294 MM GRIS DISPONIBLE EN BLANCO Y ANTRACITA	



### DOBLE ALZADA

EMB. 4 UDS.

FONDO	45	50
ALTURA 14	CO.0103840E3	CO.0103850E3
ALTURA 20	CO.0103840E4	CO.0103850E4



## 01. CAJONES, GUÍAS Y CUBERTEROS

### CAJONES

#### ACCESORIOS CAJÓN INTERIOR

CÓDIGO	DESCRIPCIÓN	EMB. 10 UDS.
CO.0103F	FRONTAL CAJÓN INTERIOR 1100MM	

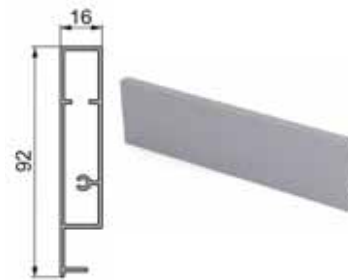

#### TUBO TRANSVERSAL

CÓDIGO	DESCRIPCIÓN	EMB. 10 UDS.
CO.0103T	TUBO TRANSVERSAL CACEROLERO INTERIOR 1130MM	



#### JUEGO ENGANCHE CAJÓN INTERIOR

CÓDIGO	DESCRIPCIÓN	EMB. 4 JUEGOS
CO.0103IC	JUEGO DE ENGANCHE CAJÓN INTERIOR ALT. 8	



H. 83

#### JUEGO ENGANCHE CACEROLERO INTERIOR

CÓDIGO	DESCRIPCIÓN	EMB. 4 JUEGOS
CO.0103ICCA	JUEGO DE ENGANCHE CACEROLERO INTERIOR ALT. 14	

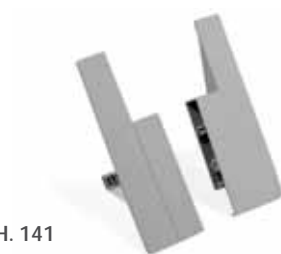

H. 141

#### JUEGO ENGANCHE CACEROLERO INTERIOR

CÓDIGO	DESCRIPCIÓN	EMB. 4 JUEGOS
CO.0103ICC	JUEGO DE ENGANCHE CACEROLERO INTERIOR ALT. 20	



H. 204

CAJONES  
**ADVANCED**

Serie EVOLUTION



 **COALFE**



# ADVANCED

EVOLUTION



4D es el acrónimo que sitúa al cajón Advanced en una cuarta dimensión. Como elemento diferenciador de gran parte de las opciones del mercado, Advanced incluye en todas las alturas de su programa, la tercera regulación denominada de **abatimiento**. Esta regulación, permite la perfecta alineación de todos los frentes de la cocina, para conseguir un diseño y calidad de percepción de alto nivel.

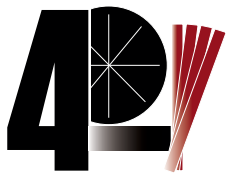

**4ª Dimensión**



**Montaje rápido**



**Calidad de acabados**



**Diseño minimalista**



**3 Alturas**  
87 mm.  
117 mm.  
167 mm.



**5 Fondos**  
300 mm.  
350 mm.  
400 mm.  
450 mm.  
500 mm.





CAJONES  
COSTADO FINO

# ADVANCED

Series EVOLUTION

## CAJONES ADVANCED

EMB. 6 UDS.

4D

FONDO	30	35	40	45	50
H87	CO.0I03830CI0	CO.0I03835CI0	CO.0I03840CI0	CO.0I03845CI0	CO.0I03850CI0
H117	CO.0I03830CI3	CO.0I03835CI3	CO.0I03840CI3	CO.0I03845CI3	CO.0I03850CI3
H167	CO.0I03830CI8	CO.0I03835CI8	CO.0I03840CI8	CO.0I03845CI8	CO.0I03850CI8

DISPONIBLES EN COLOR ANTRACITA Y BLANCO

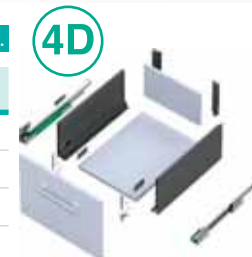

## KIT CAJÓN ADVANCED FRENO 50KG

EMB. 6 UDS.

CÓDIGO	DESCRIPCIÓN
CO.0I03850CI85	KIT CAJÓN ADVANCE H180*FONDO500 GUÍA 50KG. DISPONIBLE EN COLOR ANTRACITA Y BLANCO



## KIT CAJÓN ADVANCED GUÍAS PUSH H87

EMB. 6 UDS.

FONDO	30	35	40	45	50
H87	CO.0I03830CI0P	CO.0I03835CI0P	CO.0I03840CI0P	CO.0I03845CI0P	CO.0I03850CI0P

DISPONIBLES EN COLOR ANTRACITA Y BLANCO



## JUEGO VARILLAS

EMB. 20 JUEGOS

CÓDIGO	DESCRIPCIÓN
CO.0103CV50	JUEGO VARILLAS CAJÓN ADVANCED F50 ALTURA LIBRE DISPONIBLES EN COLOR ANTRACITA Y BLANCO



## SET ALZADA CRISTAL

EMB. 1 UDS.

CÓDIGO	DESCRIPCIÓN
CO.0103CC50	SET ALZADA CRISTAL. MODULO 50 DISPONIBLES EN COLOR ANTRACITA Y BLANCO



## ACCESORIOS CAJÓN INTERIOR

CÓDIGO	DESCRIPCIÓN	EMB.
CO.0103FCA	FRONTAL CAJON INTERIOR ANTRACITA 1200 MM	10 UDS.
CO.0103TCA	TUBO TRANSVERSAL CACEROLERO ANTRACITA 1200 MM	50 UDS.
CO.0103I10AA	SET TAPAS CAJÓN INTERIOR H90 ANTRACITA	50 UDS.
CO.0103I13AA	SET TAPAS CAJÓN INTERIOR H130 ANTRACITA	50 UDS.
CO.0103I18AA	SET TAPAS CAJÓN INTERIOR H180 ANTRACITA	50 UDS.

DISPONIBLES EN COLOR ANTRACITA Y BLANCO



CÓDIGO	DESCRIPCIÓN	EMB.
D.0314920	CONECTOR FONDO CAJÓN GRIS	100 UDS.





# CAJONES ATIRA

## COSTADO CAJÓN

CÓDIGO	DESCRIPCIÓN	EMB. 18 UDS.
CO.0104H26	JUEGO COSTADO CAJÓN HETTICH F.26	
CO.0104H35	JUEGO COSTADO CAJÓN HETTICH F.35	
CO.0104H42	JUEGO COSTADO CAJÓN HETTICH F.42	
CO.0104H47	JUEGO COSTADO CAJÓN HETTICH F.47	
	DISPONIBLE EN ANTRACITA GRIS Y BLANCO	



## JUEGO VARILLAS

CÓDIGO	DESCRIPCIÓN	EMB. 80 UDS.
CO.0104HV26	JUEGO VARILLAS FONDO 26 HETTICH	
CO.0104HV35	JUEGO VARILLAS FONDO 35 HETTICH	
CO.0104HV42	JUEGO VARILLAS FONDO 42 HETTICH	
CO.0104HV47	JUEGO VARILLAS FONDO 47 HETTICH	
CO.0104HV47D	JUEGO VARILLAS FONDO 47 CACEROLERO DOBLE HETTICH	



## GUÍAS CAJÓN

CÓDIGO	DESCRIPCIÓN	EMB. 18 UDS.
CO.0104H26G	JUEGO GUÍA QUADRO V.6/260 HETTICH	
CO.0104H35G	JUEGO GUÍA QUADRO V.6/350 HETTICH	
CO.0104H42G	JUEGO GUÍA QUADRO V.6/420 HETTICH	
CO.0104H47G	JUEGO GUÍA QUADRO V.6/470 HETTICH	
CO.0104H47G5	JUEGO GUÍA QUADRO V.6/470 50KG. HETTICH	



## GUÍAS PUSH TOP OPEN CAJÓN

CÓDIGO	DESCRIPCIÓN	EMB. 18 UDS.
CO.0104H26GP	JUEGO GUÍAS QUADRO V.6/260 PUSH TO OPEN HETTICH	
CO.0104H35GP	JUEGO GUÍAS QUADRO V.6/350 PUSH TO OPEN HETTICH	
CO.0104H42GP	JUEGO GUÍAS QUADRO V.6/420 PUSH TO OPEN HETTICH	
CO.0104H47GP	JUEGO GUÍAS QUADRO V.6/470 PUSH TO OPEN HETTICH	



## ACCESORIOS CAJÓN

### TAPAS COSTADO

CÓDIGO	DESCRIPCIÓN	EMB. 300 UDS.
CO.0104HT	JUEGO TAPA COSTADO GRIS HETTICH	



## ACCESORIOS CAJÓN

### CONECTORES

CÓDIGO	DESCRIPCIÓN	EMB. 400 UDS.
CO.0104HA	JUEGO ANCLAJE DELANTERO HETTICH	
CO.0104HT0	JUEGO TORNILLO FIJACIÓN LATERAL HETTICH	



CÓDIGO	DESCRIPCIÓN	EMB. 40 UDS.
CO.0104HC	JUEGO ANCLAJE TRASERO DE CAJÓN HETTICH 70 MM	
CO.0104HCC	JUEGO ANCLAJE TRASERO DE CACEROLERO HETTICH 144 MM	
CO.0104HCCD	JUEGO ANCLAJE TRASERO DE CACEROLERO DOBLEHETTICH 176 MM	



### TRASERAS METÁLICAS ALTURA 70 CAJÓN ATIRA

CÓDIGO	DESCRIPCIÓN	
CO.0104727H3	TRASERA METÁLICAS ALT.70 MOD. 27 HETTICH	
CO.0104730H3	TRASERA METÁLICAS ALT.70 MOD. 30 HETTICH	
CO.0104735H3	TRASERA METÁLICAS ALT.70 MOD. 35 HETTICH	
CO.0104740H3	TRASERA METÁLICAS ALT.70 MOD. 40 HETTICH	EMB. 40 UDS.
CO.0104745H3	TRASERA METÁLICAS ALT.70 MOD. 45 HETTICH	
CO.0104750H3	TRASERA METÁLICAS ALT.70 MOD. 50 HETTICH	
CO.0104755H3	TRASERA METÁLICAS ALT.70 MOD. 55 HETTICH	
CO.0104760H3	TRASERA METÁLICAS ALT.70 MOD. 60 HETTICH	
CO.0104770H3	TRASERA METÁLICAS ALT.70 MOD. 70 HETTICH	
CO.0104780H3	TRASERA METÁLICAS ALT.70 MOD. 80 HETTICH	
CO.0104790H3	TRASERA METÁLICAS ALT.70 MOD. 90 HETTICH	EMB. 20 UDS.
CO.01047100H3	TRASERA METÁLICAS ALT.70 MOD 100 HETTICH	
CO.01047120H3	TRASERA METÁLICAS ALT.70 MOD 120 HETTICH	



### TRASERAS METÁLICAS ALTURA 144 CAJÓN ATIRA

CÓDIGO	DESCRIPCIÓN	
CO.01041427H4	TRASERA METÁLICAS ALT.144 MOD. 27 HETTICH	
CO.01041430H4	TRASERA METÁLICAS ALT.144 MOD. 30 HETTICH	
CO.01041435H4	TRASERA METÁLICAS ALT.144 MOD. 35 HETTICH	
CO.01041440H4	TRASERA METÁLICAS ALT.144 MOD. 40 HETTICH	EMB. 20 UDS.
CO.01041445H4	TRASERA METÁLICAS ALT.144 MOD. 45 HETTICH	
CO.01041450H4	TRASERA METÁLICAS ALT.144 MOD. 50 HETTICH	
CO.01041455H4	TRASERA METÁLICAS ALT.144 MOD. 55 HETTICH	
CO.01041460H4	TRASERA METÁLICAS ALT.144 MOD. 60 HETTICH	
CO.01041470H4	TRASERA METÁLICAS ALT.144 MOD. 70 HETTICH	
CO.01041480H4	TRASERA METÁLICAS ALT.144 MOD. 80 HETTICH	
CO.01041490H4	TRASERA METÁLICAS ALT.144 MOD. 90 HETTICH	EMB. 10 UDS.
CO.010414100H4	TRASERA METÁLICAS ALT.144 MOD 100 HETTICH	
CO.010414120H4	TRASERA METÁLICAS ALT.144 MOD 120 HETTICH	



CAJÓN ATIRA

ALZADAS METÁLICAS

CÓDIGO	DESCRIPCIÓN	EMB. 1 JUEGO
CO.0104826H5A	JUEGO TOP SIDE METÁLICO HETTICH F - 26	
CO.0104835H5A	JUEGO TOP SIDE METÁLICO HETTICH F - 35	
CO.0104842H5A	JUEGO TOP SIDE METÁLICO HETTICH F - 42	
CO.0104847H5A	JUEGO TOP SIDE METÁLICO HETTICH F - 47	

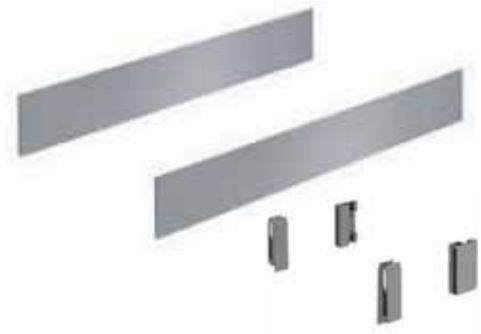

ALZADAS CRISTAL

CÓDIGO	DESCRIPCIÓN	EMB. 1 JUEGO
CO.0104826H5B	JUEGO DESIGNSIDE CRISTAL HETTICH F - 26	
CO.0104835H5B	JUEGO DESIGNSIDE CRISTAL HETTICH F - 35	
CO.0104842H5B	JUEGO DESIGNSIDE CRISTAL HETTICH F - 42	
CO.0104847H5B	JUEGO DESIGNSIDE CRISTAL HETTICH F - 47	

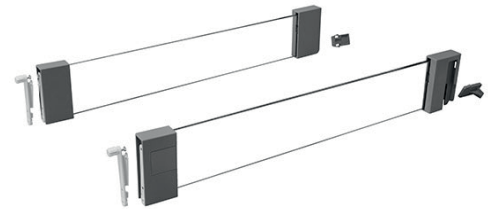

ACCESORIOS CAJÓN INTERIOR

CÓDIGO	DESCRIPCIÓN	EMB. 1 UD.
CO.01048H6	FRENTE PARA CAJÓN INTERIOR HETTICH (TIRAS 2 METROS)	



CÓDIGO	DESCRIPCIÓN	EMB. 1 JUEGO
CO.01048H7	JUEGO ANCLAJE CAJÓN INTERIOR HETTICH H93	
CO.01048H8	JUEGO ANCLAJE CACEROLERO INTERIOR HETTICH H144	



CÓDIGO	DESCRIPCIÓN	EMB. 10 UDS.
CO.01048H9	BARRA FRENTE CACEROLERO INTERIOR HETTICH 2000MM	



SET PUSH ATIRA

CÓDIGO	DESCRIPCIÓN	EMB. 1 JUEGO
CO.0104HPA	SET PUSH ATIRA LONGITUD 260-520 MM 10-30 KG.	
CO.0104HPA1	SET PUSH ATIRA LONGITUD 260-520 MM 8-20 KG.	



CÓDIGO	DESCRIPCIÓN	EMB. 100 UDS.
H.9236718	BARRA SINCRONIZADORA (TIRAS 2 METROS)	



# CAJÓN ARCITECH



## COSTADO CAJÓN

CÓDIGO	DESCRIPCIÓN	EMB. 15 UDS.
CO.0104H27AA	JUEGO COSTADO CAJON HETTICH ARCITECH F.27 H.94	
CO.0104H35AA	JUEGO COSTADO CAJON HETTICH ARCITECH F.35 H.94	
CO.0104H40AA	JUEGO COSTADO CAJON HETTICH ARCITECH F.40 H.94	
CO.0104H45AA	JUEGO COSTADO CAJON HETTICH ARCITECH F.45 H.94	
CO.0104H50AA	JUEGO COSTADO CAJON HETTICH ARCITECH F.50 H.94	
CO.0104H50A12A	JUEGO COSTADO CAJON HETTICH ARCITECH F.50 H.126	
	DISPONIBLES EN COLOR ANTRACITA, GRIS Y BLANCO	



## JUEGO VARILLAS

CÓDIGO	DESCRIPCIÓN	EMB. 30 UDS.
CO.0104HV27A	JUEGO VARILLAS F - 27 HETTICH ARCITECH	
CO.0104HV35A	JUEGO VARILLAS F - 35 HETTICH ARCITECH	
CO.0104HV40A	JUEGO VARILLAS F - 40 HETTICH ARCITECH	
CO.0104HV45A	JUEGO VARILLAS F - 45 HETTICH ARCITECH	
CO.0104HV50A	JUEGO VARILLAS F - 50 HETTICH ARCITECH	
	DISPONIBLES EN COLOR ANTRACITA, GRIS Y BLANCO	



## GUÍAS CAJÓN

CÓDIGO	DESCRIPCIÓN	EMB. 15 UDS.
CO.0104H27GAA	JUEGO GUÍA ACTRO SILENT SYSTEM ARCITECH F.27 40KG.	
CO.0104H35GAA	JUEGO GUÍA ACTRO SILENT SYSTEM ARCITECH F.35 40KG.	
CO.0104H40GAA	JUEGO GUÍA ACTRO SILENT SYSTEM ARCITECH F.40 40KG.	
CO.0104H45GAA	JUEGO GUÍA ACTRO SILENT SYSTEM ARCITECH F.45 40KG.	
CO.0104H50GAA	JUEGO GUÍA ACTRO SILENT SYSTEM ARCITECH F.50 40KG.	
CO.0104H50GAA6	JUEGO GUÍA ACTRO SILENT SYSTEM ARCITECH F.50 70KG.	
CO.0104H50GAA8	JUEGO GUÍA ACTRO SILENT SYSTEM ARCITECH F.50 80KG.	



## SET PUSH ARCITECH

CÓDIGO	DESCRIPCIÓN	EMB. 15 UDS.
CO.0104HP	SET PUSH ARCITECH LONGITUD 270-650 MM 10 - 40 KG.	
CO.0104HP1	SET PUSH ARCITECH LONGITUD 270-650 MM 8 - 20 KG.	



CÓDIGO	DESCRIPCIÓN	EMB. 100 UDS.
H.9236718	BARRA SINCRONIZADORA (TIRAS 2 METROS)	



## ACCESORIOS CAJÓN

CÓDIGO	DESCRIPCIÓN	EMB. 300 UDS.
CO.0104HTAA	JUEGO TAPA HETTICH COSTADO ARCITECH ANTRACITA	
	DISPONIBLES EN COLOR ANTRACITA Y BLANCO	



## ARCITECH

## ACCESORIOS CAJÓN ARCITECH

CÓDIGO	DESCRIPCIÓN	EMB. 150 UDS.
CO.0104HAAA	JUEGO ANCLAJE DELANTERO HETTICH ARCITECH	EMB. 150 UDS.
CO.0104HT0AA	JUEGO TORNILLO FIJACION VARILLA HETTICH ARCITECH	EMB. 400 UDS.



CÓDIGO	DESCRIPCIÓN	EMB. 30 UDS.
CO.0104HCAA	JUEGO ANCLAJE TRASERO DE CAJON HETTICH ARCITECH H.94	EMB. 30 UDS.
CO.0104HCAA12	JUEGO ANCLAJE TRASERO DE CAJON HETTICH ARCITECH H.126	
CO.0104HCCAA	JUEGO ANCLAJE TRASERO DE CACEROLERO HETTICH ARCITECH H.186	
CO.0104HCCAA21	JUEGO ANCLAJE TRASERO DE CACEROLERO HETTICH ARCITECH H.218	
CO.0104HCCAA25	JUEGO ANCLAJE TRASERO DE CACEROLERO HETTICH ARCITECH DE H.250	
CO.0104HCCAA28	JUEGO ANCLAJE TRASERO DE CACEROLERO HETTICH ARCITECH H.280	



## ALZADA METÁLICA

CÓDIGO	DESCRIPCIÓN	EMB. 1 JUEGO
CO.0104840H5AA	SET TOPSIDE ARCITECH ANTRACITA F.40	EMB. 1 JUEGO
CO.0104845H5AA	SET TOPSIDE ARCITECH ANTRACITA F.45	
CO.0104850H5AA	SET TOPSIDE ARCITECH ANTRACITA F.50	
	DISPONIBLES EN COLOR ANTRACITA, GRIS Y BLANCO	



## ALZADA CRISTAL

CÓDIGO	DESCRIPCIÓN	EMB. 1 JUEGO
CO.0104827H5CAA	SET DESIGNSIDE CRISTAL ARCITECH ANTRACITA F.27	EMB. 1 JUEGO
CO.0104835H5CAA	SET DESIGNSIDE CRISTAL ARCITECH ANTRACITA F.35	
CO.0104840H5CAA	SET DESIGNSIDE CRISTAL ARCITECH ANTRACITA F.40	
CO.0104845H5CAA	SET DESIGNSIDE CRISTAL ARCITECH ANTRACITA F.45	
CO.0104850H5CAA	SET DESIGNSIDE CRISTAL ARCITECH ANTRACITA F.50	



## ACCESORIOS CAJÓN INTERIOR

CÓDIGO	DESCRIPCIÓN	EMB. 1 UD.
CO.01048H6AA	FRONTAL INT. ARCITECH DE 2000 ANTRACITA	EMB. 1 UD.



CÓDIGO	DESCRIPCIÓN	EMB. 1 JUEGO
CO.01048H7AA	JUEGO ANCL.CAJON INTE. ARCITECH ANTRACITA	EMB. 1 JUEGO



H.94

CÓDIGO	DESCRIPCIÓN	EMB. 1 JUEGO
CO.01048H8AA	JUEGO ANC. CACER. INTE. ARCITECH ANTRACITA	EMB. 1 JUEGO



H.186

CÓDIGO	DESCRIPCIÓN	EMB. 1 UD.
CO.01048H9AA	TUBO TRANSVERS. INTER. 2000 ARCITECH ANTRACITA	EMB. 1 UD.
	DISPONIBLES EN COLOR ANTRACITA, GRIS Y BLANCO	
	DISPONIBLES EN COLOR ANTRACITA, GRIS Y BLANCO	



# AvanTech YOU



Tan individual como tú





Technik für Möbel

  
**Hettich**



# CAJÓN AVANTECH YOU



## COSTADO CAJÓN H-77

FONDO	45	50
ANTRACITA	CO.01047H45AA	CO.01047H50AA
BLANCO	CO.01047H45AB	CO.01047H50AB

## COSTADO CAJÓN H-101

FONDO	27	30	35	40	45	50	60
ANTRACITA	CO.010410H27AA	CO.010410H30AA	CO.010410H35AA	CO.010410H40AA	CO.010410H45AA	CO.010410H50AA	CO.010410H60AA
BLANCO	CO.010410H27AB	CO.010410H30AB	CO.010410H35AB	CO.010410H40AB	CO.010410H45AB	CO.010410H50AB	CO.010410H60AB

## COSTADO CAJÓN H-139

FONDO	27	30	35	40	45	50	60
ANTRACITA	CO.010410H27AA	CO.010410H30AA	CO.010410H35AA	CO.010410H40AA	CO.010410H45AA	CO.010410H50AA	CO.010410H60AA
BLANCO	CO.010410H27AB	CO.010410H30AB	CO.010410H35AB	CO.010410H40AB	CO.010410H45AB	CO.010410H50AB	CO.010410H60AB

## COSTADO CAJÓN H-187

FONDO	27	30	35	40	45	50	60
ANTRACITA	CO.010418H27AA	CO.010418H30AA	CO.010418H35AA	CO.010418H40AA	CO.010418H45AA	CO.010418H50AA	CO.010418H60AA
BLANCO	CO.010418H27AB	CO.010418H30AB	CO.010418H35AB	CO.010418H40AB	CO.010418H45AB	CO.010418H50AB	CO.010418H60AB

## COSTADO CAJÓN H-251

FONDO	35	40	45	50	60
ANTRACITA	CO.010425H35AA	CO.010425H40AA	CO.010425H45AA	CO.010425H50AA	CO.010425H60AA
BLANCO	CO.010425H35AB	CO.010425H40AB	CO.010425H45AB	CO.010425H50AB	CO.010425H60AB

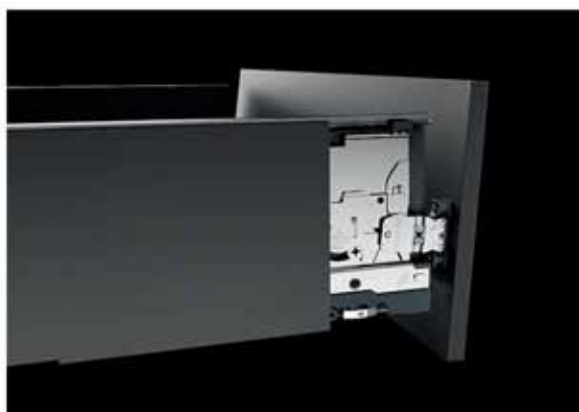

GUÍAS AVANTECH YOU

GUÍAS QUADRO YOU Y ACTRO YOU

FONDO	27	30	35	40	45	50	60
QUADRO YOU 30 KG	CO.010427HGY	CO.010430HGY	CO.010435HGY	CO.010440HGY	CO.010445HGY	CO.010450HGY	CO.010460HGY
ACTRO YOU 40 KG	CO.010427HGA	CO.010430HGA	CO.010435HGA	CO.010440HGA	CO.010445HGA	CO.010450HGA	CO.010460HGA
ACTRO YOU 70 KG					CO.010445HGA7	CO.010450HGA7	CO.010460HGA7



**Juego de Guías:**

- Extensión total para combinar con el cajón del sistema AvanTech YOU o el cajón de madera con gatillos
- Amortiguación Silent System integrada
- Reequipamiento opcional con Push to open Silent
- Capacidades de carga M (30KG) / L (40 kg) / XL (70 kg)
- Capacidad de carga según EN 15338, nivel 3
- Acero cincado

**Indicaciones:**

- Push to open Silent para Quadro YOU con Silent System puede pedirse por separado
- El pestillo para uso con cajones de madera se puede pedir por separado

**Carga máxima:** LOS SÍMBOLOS 30KG. 40 KG. Y 70 KG.

PERFILES DECORATIVOS AVANTECH YOU

LONGITUD MM.	27	30	35	40	45	50	55	60
PERFILES DECORATIVOS AVANTECH YOU	H.9255822	H.9255823	H.9255824	H.9255825	H.9255826	H.9255827	H.9255828	H.9255829

DISPONIBLES EN COLORES PLATA, BLANCO, ANTRACITA, ACERO INOX, CROMO, ROBLE Y NOGAL



SET DE COSTADO CON ELEMENTO DE INSERCIÓN ALTURA 187 MM

LONGITUD MM.	350	400	450	500	550	600
SET DE COSTADO, ALTURA 187 MM	H.9257187	H.9257188	H.9257189	H.9257190	H.9257191	H.9257192

DISPONIBLE EN PLATA, BLANCO Y ANTRACITA

SET COMPUESTO POR:

- 1 COSTADO DE INSERCIÓN IZQUIERDA Y DERECHA
- 2 PERFILES DE DISEÑO EN COLOR DE COSTADO
- 2 FIJACIONES DE FRENTE PARA COSTADO DE INSERCIÓN DE MONTAJE DE TIRAFONDOS
- 2 ESTABILIZADORES DE TRASERA
- MATERIAL DE FIJACIÓN

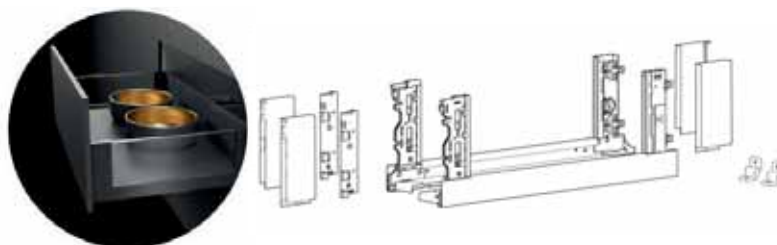

CONECTOR FRONTAL AVANTECH YOU

CÓDIGO	DESCRIPCIÓN
H.9255832	CONECTOR FRENTE PARA CAJON AVANTECH H-77
H.9255835	CONECTOR FRENTE PARA CAJON AVANTECH H-101
H.9257884	CONECTOR FRENTE PARA CAJON AVANTECH H-139
H.9255838	CONECTOR FRENTE PARA CAJON AVANTECH H-187/251
H.9257702	ESTABILIZADOR DE TRASERA DE MADERA CAJÓN AVANTECH
H.9257887	ESTABILIZADOR FRENTE H251 AVANTECH YOU HETTICH



H.9255832  
H.9255835  
H.9257884  
H.9255838

H.9257887

H.927702

# CAJÓN INTERIOR AVANTECH YOU



## ACCESORIOS CAJÓN INTERIOR AVANTECH YOU

CÓDIGO	DESCRIPCIÓN
H.9257273	FRENTE DE 2 METROS CAJÓN INTERIOR AVANTECH H-101 BLANCO
H.9257274	FRENTE DE 2 METROS CAJÓN INTERIOR AVANTECH H-139 BLANCO
H.9257275	FRENTE DE 2 METROS CAJÓN INTERIOR AVANTECH H-187 BLANCO
H.9257277	FRENTE DE 2 METROS CAJÓN INTERIOR AVANTECH H-101 ANTRACITA
H.9257278	FRENTE DE 2 METROS CAJÓN INTERIOR AVANTECH H-139 ANTRACITA
H.9257279	FRENTE DE 2 METROS CAJÓN INTERIOR AVANTECH H-187 ANTRACITA



## CONECTORES AVANTECH YOU

CÓDIGO	DESCRIPCIÓN
H.9257615	SET CONECTOR + TAPA FRENTE INTERIOR AVANTECH H-101 BLANCO
H.9257616	SET CONECTOR + TAPA FRENTE INTERIOR AVANTECH H-139 BLANCO
H.9257617	SET CONECTOR + TAPA FRENTE INTERIOR AVANTECH H-187 BLANCO
H.9257619	SET CONECTOR + TAPA FRENTE INTERIOR AVANTECH H-101 ANTRACITA
H.9257620	SET CONECTOR + TAPA FRENTE INTERIOR AVANTECH H-139 ANTRACITA
H.9257621	SET CONECTOR + TAPA FRENTE INTERIOR AVANTECH H-187 ANTRACITA



## SET PUSH AVANTECH YOU

CÓDIGO	DESCRIPCIÓN
H.9257891	SET PUSH GUÍAS AVANTECH ACTRO Y GUIAS MADERA 5D DE 8-20 KG.
H.9257892	SET PUSH GUÍAS AVANTECH ACTRO Y GUIAS MADERA 5D DE 10-40 KG.
H.9257893	SET PUSH GUÍAS AVANTECH ACTRO Y GUIAS MADERA 5D DE 20-70 KG.
H.9257895	SET PUSH TO OPEN AVANTECH PARA QUADRO YOU 8-20 KG.
H.9257896	SET PUSH TO OPEN AVANTECH PARA QUADRO YOU 10-30 KG.
H.9236718	BARRA SINCRONIZADORA PTO L2000

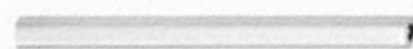
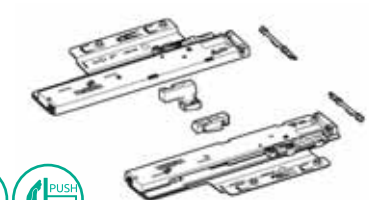



COMBINACIONES DISPONIBLES CAJONES AVANTECH YOU

		QUADRO M 30KG	ACTRO L 40KG	ACTRO XL 70KG
	MM	TRASERA MONTAJE DIRECTO	TRASERA MONTAJE DIRECTO	TRASERA MONTAJE DIRECTO
270	77	-	-	-
	101	S	S	-
	139	-	-	-
	187	S	S	-
	251	-	-	-
300	77	-	-	-
	101	S	S	-
	139	S	S	-
	187	S	S	-
	251	-	-	-
350	77	-	-	-
	101	S	S	-
	139	S	S	-
	187	S	S	-
	251	S	S	-
400	77	S	S	-
	101	S	S	-
	139	S	S	-
	187	S	S	-
	251	S	S	-
450	77	S	S	S
	101	S	S	S
	139	S	S	S
	187	S	S	S
	251	S	S	S
500	77	S	S	S
	101	S	S	S
	139	S	S	S
	187	S	S	S
	251	S	S	S
550	77	S	S	S
	101	S	S	S
	139	S	S	S
	187	S	S	S
	251	S	S	S
600	77	-	-	-
	101	S	S	S
	139	S	S	S
	187	S	S	S
	251	S	S	S
650	77	-	-	-
	101	-	-	S
	139	-	-	-
	187	-	-	S
	251	-	-	S



# GUÍAS PARA CAJÓN DE MADERA

## JUEGO GUÍAS CAJÓN MADERA

30 kg. 40 kg. 70 kg.

FONDO	27	30	35	40	45	50	55	60
FRENO	CO.0108H27	CO.0108H30	CO.0108H35	CO.0108H40	CO.0108H45	CO.0108H50	CO.0108H55	CO.0108H60



## JUEGO GUÍAS PUSH CAJÓN MADERA 30KG.

FRENO PUSH

FONDO	27	30	35	40	45	50	55	60
FRENO	CO.0107H27	CO.0107H30	CO.0107H35	CO.0107H40	CO.0107H45	CO.0107H50	CO.0107H55	CO.0107H60



## GATILLO GUÍA CAJÓN MADERA

CÓDIGO	DESCRIPCIÓN
H.9257260	GATILLO GUÍA QUADRO YOU HETTICH CAJÓN MADERA DERECHO
H.9257261	GATILLO GUÍA QUADRO YOU HETTICH CAJÓN MADERA IZQUIERDA



## JUEGO GUÍAS CAJÓN 4D

FONDO	25	30	32	35	38	40	42
4D	CO.0109H25	CO.0109H30	CO.0109H32	CO.0109H35	CO.0109H38	CO.0109H40	CO.0109H42
FONDO	45	48	50	52	55	58	60
4D	CO.0109H45	CO.0109H48	CO.0109H50	CO.0109H52	CO.0109H55	CO.0109H58	CO.0109H60

FRENO



- Cómodo montaje por deslizamiento con gatillos 4D y regulador de inclinación.
- Amortiguación integrada Silent System.
- Capacidad de carga hasta 30 kg para aplicaciones estándar. Variante disponible para cajones especialmente ligeros de hasta 10 kg.
- Se puede equipar opcionalmente con Push to open Silent: cómodo mecanismo de apertura combinado con cierre amortiguado. Ampliable con sincronización.

- Sin herramientas, ajuste intuitivo del frente del cajón: ajuste de altura hasta 2 mm; ajuste lateral de hasta +/- 1,5 mm (grosor de costado máx. 15 mm); ajuste de profundidad de hasta +/- 2 mm. Ajuste en inclinación
- Capacidad de carga según EN 15338, nivel 3
- Acero cincado

**Indicaciones:**  
El pestillo 4D y el regulador de inclinación deben pedirse por separado.

CÓDIGO	DESCRIPCIÓN
CO.0109HG	JUEGO GATILLO HETTICH CAJÓN 4D MADERA
CO.0109HRI	JUEGO REGULADOR INCLINACIÓN HETTICH CAJÓN 4D MADERA



## SET PUSH 4D

CÓDIGO	DESCRIPCIÓN
H.9246315	SET PUSH GUÍAS QUADRO 4D 8 A 20 KG.
H.9246316	SET PUSH GUÍAS QUADRO 4D 10 A 30 KG.



CÓDIGO	DESCRIPCIÓN
H.9236718	BARRA SINCRONIZADORA PTO L2000



## GUÍA ACTRO 5D

FONDO	25	30	32	35	38	40	42
5D	CO.0110H25	CO.0110H30	CO.0110H32	CO.0110H35	CO.0110H38	CO.0110H40	CO.0110H42
FONDO	45	48	50	52	55	60	
5D	CO.0110H45	CO.0110H48	CO.0110H50	CO.0110H52	CO.01109H55	CO.0110H60	



### GUÍAS EXTRACCIÓN TOTAL Y FRENO



- Extensión completa para combinar con cajón de madera.
- Integrado.
- Opcional: push to open silent.
- Ajuste de altura sin herramienta de hasta + 3 mm, ajuste lateral hasta +/- 1,5 mm, ajuste de inclinación hasta + 4 mm y ajuste radial de hasta +/- 1,5 mm.
- Opcional: ajuste de profundidad de hasta + 4 mm.
- Clases de carga L (40 kg) / XL (70 kg).
- Capacidad de carga a EN 15338, Nivel 3.
- Acero galvanizado.

**Indicaciones:**  
El pestillo debe pedirse por separado.

## JUEGO GATILLO

CÓDIGO	DESCRIPCIÓN
H.9257268	JUEGO GATILLO HETTICH CAJÓN 5D MADERA



## SET AJUSTE

CÓDIGO	DESCRIPCIÓN
H.9257706	SET AJUSTE PROFUNDIDAD HETTICH CAJÓN 5D MADERA



## SET PUSH GUÍA 5D

CÓDIGO	DESCRIPCIÓN
H.9257891	SET PUSH GUÍAS ACTRO 40KG 5D 8 A 20 KG.
H.9257892	SET PUSH GUÍAS ACTRO 40KG 5D 10 A 40 KG.
H.9257893	SET PUSH GUÍAS ACTRO 70KG 5D 20 A 70 KG.



## BARRA SINCRONIZADORA

CÓDIGO	DESCRIPCIÓN
H.9236718	BARRA SINCRONIZADORA PUSH TO OPEN L2000



## 01. CAJONES, GUÍAS Y CUBERTEROS

### CUBERTEROS

#### CUBERTEROS MADERA HAYA



ANCHO	45	50	60	70	80	90
MADERA PREMIUM	D.0302478	D.0302578	D.0302678	D.0302778	D.0302878	D.0302978
ANCHO	100	120				
MADERA PREMIUM	D.0303078	D.0303178				

#### CUBERTERO REGULABLE MADERA

CÓDIGO	DESCRIPCIÓN
CO.011060M	CUBERTERO REGULABLE MADERA MOD. 40-60
CO.011090M	CUBERTERO REGULABLE MADERA MOD. 60-100



#### CUBERTERO GAMA EMUCA - BLUM - GRASS

ANCHO	30	35	40	45	50	60
CAJÓN FRENO	CO.011030B	CO.011035B	CO.011040B	CO.011045B	CO.011050B	CO.011060B
ANCHO	70	80	90	100	120	
CAJÓN FRENO	CO.011070B	CO.011080B	CO.011090B	CO.0110100B	CO.0110120B	

#### CUBERTERO GAMA HETTICH

ANCHO	40	45	50	60
CAJÓN AUT. HETTICH	CO.011040H	CO.011045H	CO.011050H	CO.011060H
ANCHO	90	100	120	
CAJÓN AUT. HETTICH	CO.011090H	CO.0110100H	CO.0110120H	



#### CUBERTERO CAJÓN METÁLICO

FONDO	30	35	40	45	50	60
CAJÓN METÁLICO	CO.0110503005	CO.0110503505	CO.0110504005	CO.0110504505	CO.0110505005	CO.0110506005
FONDO	70	80	90	100	120	
CAJÓN METÁLICO	CO.0110507005	CO.0110508005	CO.0110509005	CO.01105010005	CO.01105012005	





# 01. CAJONES, GUÍAS Y CUBERTEROS

## CUBERTEROS

### CUBERTERO CAJÓN ADVANCED Y ACCESORIOS

ANCHO	40	45	50	60	70	80
CAJÓN ADVANCED	CO.011040AA	CO.011045AA	CO.011050AA	CO.011060AA	CO.011070AA	CO.011080AA
ANCHO	90	100	120			
CAJÓN ADVANCED	CO.011090AA	CO.0110100AA	CO.0110120AA			

DISPONIBLE EN ANTRACITA Y BLANCO



CÓDIGO	DESCRIPCIÓN
D.0102177	PORTACUCHILLOS CUBERTERO ADVANCED



Portacuchillos

CÓDIGO	DESCRIPCIÓN
D.0112720	PORTAESPECIES CUBERTERO ADVANCED



Portaespecies

CÓDIGO	DESCRIPCIÓN
CO.0110S	SEPARADOR CUBERTERO LINE GRIS
	DISPONIBLE EN ANTRACITA Y BLANCO



Separador

### CUBERTERO HETTICH

CÓDIGO	DESCRIPCIÓN	
H.919488600	IA ORGATRAY 590/300/470 PLATA	ATIRA PLATA
H.919488700	IA ORGATRAY 590/400/470 PLATA	
H.919488800	IA ORGATRAY 590/450/470 PLATA	
H.919488900	IA ORGATRAY 590/500/470 PLATA	
H.919489100	IA ORGATRAY 590/600/470 PLATA	
H.919489200	IA ORGATRAY 590/800/470 PLATA	
H.919489300	IA ORGATRAY 590/900/470 PLATA	
H.919489400	IA ORGATRAY 590/1000/470 PLATA	



ATIRA

CÓDIGO	DESCRIPCIÓN	
H.913497500	AT ORGATRAY 570/300 PR500 PL SE20619	ARCITECH PLATA
H.913497600	AT ORGATRAY 570/350 PR500 PL SE20619	
H.913497700	AT ORGATRAY 570/400 PR500 PL SE20619	
H.913497900	AT ORGATRAY 570/450 PR500 PL SE20619	
H.913498000	AT ORGATRAY 570/500 PR500 PL SE20619	
H.913499100	AT ORGATRAY 570/550 PR500 PL SE20619	
H.913499200	AT ORGATRAY 570/600 PR500 PL SE20619	
H.913499300	AT ORGATRAY 570/800 PR500 PL SE20619	
H.913499400	AT ORGATRAY 570/900 PR500 PL SE20619	
H.913499500	AT ORGATRAY 570/1000 PR500 PL SE20619	



ARCITECH

CÓDIGO	DESCRIPCIÓN	
H.9194992	IA ORGATRAY 440/175-200 ANTRACITA	CUBERTERO ORGATRAY 440 AVANTECH YOU
H.9194993	IA ORGATRAY 440/201-250 ANTRACITA	
H.9194994	IA ORGATRAY 440/251-300 ANTRACITA	
H.9194995	IA ORGATRAY 440/301-350 ANTRACITA	
H.9194996	IA ORGATRAY 440/351-400 ANTRACITA	
H.9194997	IA ORGATRAY 440/401-450 ANTRACITA	
H.9194998	IA ORGATRAY 440/451-500 ANTRACITA	
H.9194999	IA ORGATRAY 440/501-600 ANTRACITA	
H.9195000	IA ORGATRAY 440/601-700 ANTRACITA	
H.9195001	IA ORGATRAY 440/701-800 ANTRACITA	
H.9195002	IA ORGATRAY 440/801-900 ANTRACITA	
H.9195004	IA ORGATRAY 440/1091-1150 ANTRACITA	
	DISPONIBLES EN ANTRACITA Y BLANCO	



AVANTECH YOU

## 01. CAJONES, GUÍAS Y CUBERTEROS

# GUÍAS BOLAS

### GUÍAS BOLAS EXTRACCIÓN TOTAL

EMB. 10 JUEGOS

FONDO	25	30	35	40	45	50
EXTRACCIÓN TOTAL	CO.GET25	CO.GET30	CO.GET35	CO.GET40	CO.GET45	CO.GET50
FONDO	55	60	70	80	100	
EXTRACCIÓN TOTAL	CO.GET55	CO.GET60	CO.GET70	CO.GET80	CO.GET100	



**Juego de Guías**  
Telescópicas  
**EXTRACCIÓN TOTAL**

Dimensiones:  
1.2x1.2x1.5mm  
Ancho: 45mm  
Carga máxima: **30KG**



### GUÍAS BOLAS EXTRACCIÓN TOTAL AUTOCIERRE Y FRENO

EMB. 10 JUEGOS

FONDO	25	30	35	40	45	50
EXT. TOT. AUTOCIERRE Y FRENO	CO.GEAF25	CO.GEAF30	CO.GEAF35	CO.GEAF40	CO.GEAF45	CO.GEAF50
FONDO	55	60	70	80	100	
EXT. TOT. AUTOCIERRE Y FRENO	CO.GEAF55	CO.GEAF60	CO.GEAF70	CO.GEAF80	CO.GEAF100	

**Juego de Guías**  
Telescópicas  
Extracción Total  
**AUTOCIERRE Y FRENO**

Dimensiones:  
1.2x1.2x1.5mm  
Ancho: 45mm  
Carga máxima: **30KG**



### GUÍAS BOLAS PUSH TO OPEN Y FRENO

EMB. 10 JUEGOS

FONDO	25	30	35	40	45	50
PUSH TO OPEN Y FRENO	CO.GEAFP25	CO.GEAFP30	CO.GEAFP35	CO.GEAFP40	CO.GEAFP45	CO.GEAFP50
FONDO	55	60	70	80	100	
PUSH TO OPEN Y FRENO	CO.GEAFP55	CO.GEAFP60	CO.GEAFP70	CO.GEAFP80	CO.GEAFP100	

**Juego de Guías**  
Telescópicas  
Extracción Total  
**PUSH TO OPEN Y FRENO**

Dimensiones:  
1.2x1.2x1.5mm  
Ancho: 45mm  
Carga máxima: **30KG**



### GUÍAS METÁLICAS

EMB. 10 JUEGOS

FONDO	25	30	35	40	45	50	55	60
GRIS	CO.01062504	CO.01063004	CO.01063504	CO.01064004	CO.01064504	CO.01065004	CO.01065504	CO.01066004
BLANCA	CO.01062501	CO.01063001	CO.01063501	CO.01064001	CO.01064501	CO.01065001	CO.01065501	CO.01066001



# GUÍAS PARA CAJÓN MADERA



## GUÍAS CAJÓN MADERA EXTRACCIÓN TOTAL CON GATILLO

EMB. 10 JUEGOS

FONDO	30	35	40	45	50	55
EXTRACCIÓN TOTAL GATILLO	CO.0108G30	CO.0108G35	CO.0108G40	CO.0108G45	CO.0108G50	CO.0108G55

VÁLIDO PARA COSTADO DE 16-19



Juego de Guías  
Oculta  
**EXTRACCIÓN TOTAL**  
Carga máxima: **30 KG.**



## GUÍAS CAJÓN MADERA EXTRACCIÓN TOTAL Y PUSH

EMB. 10 JUEGOS

FONDO	30	35	40	45	50	55
EXTRACCIÓN TOTAL PUSH	CO.0108G30P	CO.0108G35P	CO.0108G40P	CO.0108G45P	CO.0108G50P	CO.0108G55P

VÁLIDO PARA COSTADO DE 16-19



Juego de Guías  
Oculta  
**EXTRACCIÓN TOTAL**  
Carga máxima: **30 KG.**



## 02. PROTECTORES Y ESCURREPLATOS



PROTECTORES FREGADERO

# PROTECTORES FREGADERO



ANTRACITA



ALUMINIO



RINCÓN



ABS

### PROTECTOR FREGADERO COLOR ANTRACITA

EMB. 10 UDS.

ANCHO	40	45	50	60	70	80
ANTRACITA	CO.02015840C	CO.02015845C	CO.02015850C	CO.02015860C	CO.02015870C	CO.02015880C
ANCHO	90	100	110	120	130	140
ANTRACITA	CO.02015890C	CO.020158100C	CO.020158100C	CO.020158120C	CO.020158130C	CO.020158140C

### PROTECTOR FREGADERO ALUMINIO

EMB. 10 UDS.

ANCHO	40	45	50	60	70
PROT. ALUMINIO	CO.02015840	CO.02015845	CO.02015850	CO.02015860	CO.02015870
ANCHO	80	90	100	120	135
PROT. ALUMINIO	CO.02015880	CO.02015890	CO.020158100	CO.020158120	CO.020158135

### PROTECTOR FREGADERO RINCÓN

EMB. 10 UDS.

CÓDIGO	DESCRIPCIÓN
CO.0201R99	PROTECTOR FREGADERO RINCON MOD.99

### PROTECTOR FREGADERO ABS PERFIL ALUMINIO

EMB. 12 UDS.

ANCHO	40	45	50	60	70
PROTECTOR ABS	CO.02015840B	CO.02015845B	CO.02015850B	CO.02015860B	CO.02015870B
ANCHO	80	90	100	120	135
PROTECTOR ABS	CO.02015880B	CO.02015890B	CO.020158100B	CO.020158120B	CO.020158135B

NEW

### ESTERILLA ANTIDESLIZANTE

CÓDIGO	DESCRIPCIÓN
D.0300207	ESTERILLA ANTIDESLIZANTE AGO TEX 600 X 473 ANTRACITA
D.0300307	ESTERILLA ANTIDESLIZANTE AGO TEX 900 X 473 ANTRACITA
D.0300407	ESTERILLA ANTIDESLIZANTE AGO TEX 1200 X 473 ANTRACITA

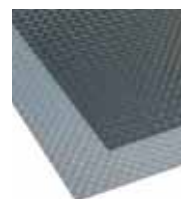

CÓDIGO	DESCRIPCIÓN	EMB. 20 METROS
CO.010905	ROLLO ESTERILLA ANTIDESLIZANTE (20 METROS) DISPONIBLE EN GRIS, BLANCO Y ANTRACITA	



## 02. PROTECTORES Y ESCURREPLATOS

### ESCURREPLATOS

#### ESCURREPLATOS INOX

EMB. 1 UD.

ANCHO	40	45	50	60	70	80	90	100
INOX	CO.02020440	CO.02020445	CO.02020450	CO.02020460	CO.02020470	CO.02020480	CO.02020490	CO.020204100



#### ESCURREPLATOS PVC

EMB. 1 UD.

ANCHO	40	45	50	60	70	80	90
PVC BLANCO	CO.02024001	CO.02024501	CO.02025001	CO.02026001	CO.02027001	CO.02028001	CO.02029001



#### ESCURREPLATOS EPOXI

EMB. 5 UDS.

ANCHO	40	45	50	60	70	80	90
VARILLA EPOXI	CO.02020340	CO.02020345	CO.02020350	CO.02020360	CO.02020370	CO.02020380	CO.02020390



#### BANDEJA RECOGE AGUA PVC

EMB. 10 UDS.

ANCHO	40	45	50	60	70	80	90
B. BLANCA EPOXI	CO.02EP40	CO.02EP45	CO.02EP50	CO.02EP60	CO.02EP70	CO.02EP80	CO.02EP90



#### PISTONES

##### PISTÓN GAS

CÓDIGO	DESCRIPCIÓN	EMB. 20 UDS.
CO.030100	PISTÓN GAS INVERSO	
CO.030106	PISTÓN GAS DE 6KG. 247 MM	
CO.030108	PISTÓN GAS DE 8 KG. 247MM	
CO.030110	PISTÓN GAS DE 10 KG. 247MM	
CO.030112	PISTÓN GAS DE 12 KG. 247MM	

CÓDIGO	DESCRIPCIÓN	EMB. 20 UDS.
CO.030208	PISTÓN GAS CORTO DE 8KG. 164MM	
CO.030205	PISTÓN GAS CORTO DE 5KG. 164MM	
CO.030206	FRENO PISTÓN GAS EN GRIS	

CÓDIGO	DESCRIPCIÓN	EMB. 20 UDS.
CO.030106F	PISTÓN GAS FRICCIÓN 6KG.	
CO.030108F	PISTÓN GAS FRICCIÓN 8KG.	
CO.030110F	PISTÓN GAS FRICCIÓN 10KG.	



##### COMPÁS

CÓDIGO	DESCRIPCIÓN	EMB. 50 UDS.
CO.03D	SET COMPÁS DUO	
D.0120693	ADAPTADOR VITRINA ALUMINIO 20 x 20	



**Adaptador Vitrina Aluminio 20x20**

##### FREELIGHT

CÓDIGO	DESCRIPCIÓN	EMB. 1 UD.
CO.031101	SET FREELIGHT TIPO A	
CO.031102	SET FREELIGHT TIPO B	
CO.031103	SET FREELIGHT TIPO C	
CO.031104	SET FREELIGHT TIPO D	



##### SET EWIVA

CÓDIGO	DESCRIPCIÓN	EMB. 1 UD.
D.031720	SET EWIVA MOD. 60	
D.0302020	JUEGO FUERZA EWIVA 2,5/4,8 KG.	



### 03. PISTONES, SISTEMA DE APERTURA Y BISAGRAS

#### SISTEMA KIARO

CÓDIGO	DESCRIPCIÓN	
D.0100102	MECANISMO KIARO ALTO 250/500 PUERTA 2,5-11,5 KG	EMB. 1 UD.
D.0100193	COVER KIARO NIQUEL	EMB. 25 UDS.
D.0100293	SOPORTE SUPERFICIE	EMB. 1 UD.



MECANISMO KIARO



COVER KIARO NIQUEL



TAPAS KIARO



DETALLE SOPORTE EMBUTIDO



DETALLE SOPORTE SUPERFICIE



CÓDIGO	DESCRIPCIÓN
CO.031005	BISAGRA KIMANA ATORNILLABLE NIQUEL



BISAGRA KIMANA NIQUEL

#### Sus beneficios:

- » Bisagra con doble regulación automática lateral y en altura.
- » Posibilita dejar la puerta en el mismo plano en abatimiento que la base donde se fija.
- » Tapa embellecedor para la ocultación de los tornillos de regulación.









**FREEspace**



**FREESlide**



# SISTEMAS ABATIBLES

## FREE SPACE VERSIÓN ESTÁNDAR

CÓDIGO	DESCRIPCIÓN
CO.030512	SET FREE SPACE ANTRACITA/NIQUEL B 0,7/4,3 KG.
CO.030513	SET FREE SPACE ANTRACITA/NIQUEL C 1,3/7,1 KG.
CO.030514	SET FREE SPACE ANTRACITA/NIQUEL D 2,2/9,3 KG.
CO.030515	SET FREE SPACE ANTRACITA/NIQUEL E 3,2/13,4 KG.
CO.030516	SET FREE SPACE ANTRACITA/NIQUEL F 4,6/19,1 KG.
CO.030521	SET FREE SPACE ANTRACITA/NIQUEL G 6,3/18,9 KG.
CO.030522	SET FREE SPACE ANTRACITA/NIQUEL H 9,7/25,7 KG.



## FREE SPACE VERSIÓN PUSH

CÓDIGO	DESCRIPCIÓN
CO.030517	SET FREE SPACE PUSH OPEN ANTRACITA/NIQUEL B 0,7/4,3 KG.
CO.030518	SET FREE SPACE PUSH OPEN ANTRACITA/NIQUEL C 1,3/7,1 KG.
CO.030519	SET FREE SPACE PUSH OPEN ANTRACITA/NIQUEL D 2,2/9,3 KG.
CO.030520	SET FREE SPACE PUSH OPEN ANTRACITA/NIQUEL E 3,2/13,4 KG.
CO.030523	SET FREE SPACE PUSH OPEN ANTRACITA/NIQUEL F 4,6/19,1 KG.
CO.030524	SET FREE SPACE PUSH OPEN ANTRACITA/NIQUEL G 6,3/18,9 KG.
CO.030525	SET FREE SPACE PUSH OPEN ANTRACITA/NIQUEL H 9,7/25,7 KG.

FREEspace



## ACCESORIOS FREESPACE

CÓDIGO	DESCRIPCIÓN
D.0200402	BASE TYPE 3
D.0300291	SET ADAPTADOR VITRINA
D.0100200	PLANTILLA MONTAJE FREESPACE EXPULSADOR TYPE 3 (INCLUIDO EN VERSION PTO)



**Base Type 3**



**Set adaptador vitrina**

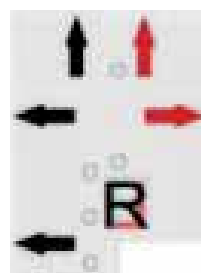

**Expulsador Type 3  
(incluido en versión PTO)**

#### SISTEMAS DE APERTURA

##### SET FREE

EMB. 10 UDS.

CÓDIGO	DESCRIPCIÓN
CO.030501A	SET FREE MINI A (ALTURA MÓDULO 200/400) (KG. PUERTA 0,8 / 3,8)
CO.030501B	SET FREE MINI B (ALTURA MÓDULO 200/400) (KG. PUERTA 1,7 / 6,4)
CO.030501	SET FREE MINI C (ALTURA MÓDULO 200/400) (KG. PUERTA 3,2 / 11,8)
CO.030502D	SET FREE D (ALTURA MÓDULO 350/650) (KG. PUERTA 3,0 / 9,6)
CO.030502E	SET FREE E (ALTURA MÓDULO 350/650) (KG. PUERTA 3,8 / 12,4)
CO.030502F	SET FREE F (ALTURA MÓDULO 350/650) (KG. PUERTA 5,7 / 18,6)
CO.030502G	SET FREE G (ALTURA MÓDULO 350/650) (KG. PUERTA 7,6 / 23,6)
TAPAS DISPONIBLES EN BLANCA Y ANTRACITA	



##### SET FOLD

EMB. 1 UD.

CÓDIGO	DESCRIPCIÓN
CO.030503	SET FOLD PUERTA 650/730
CO.030504	SET FOLD PUERTA 840/900
CO.030504B	SET FOLD PUERTA 770/840
TAPAS DISPONIBLES EN BLANCA Y ANTRACITA	



##### SET SLIDE

EMB. 1 UD.

CÓDIGO	DESCRIPCIÓN
CO.030505	SET SLIDE PUERTA 380/500
CO.030505A	SET SLIDE PUERTA 430/600
TAPAS DISPONIBLES COLOR BLANCO Y ANTRACITA	



##### SET SWING

EMB. 1 UD.

CÓDIGO	DESCRIPCIÓN
CO.030506	SET SWING PUERTA 370/500
TAPAS DISPONIBLES EN BLANCA Y ANTRACITA	



##### BARRA SLIDE Y JUEGO ADAPTADOR VITRINA ALUMINIO

CÓDIGO	DESCRIPCIÓN	EMB. 1 UD.
CO.030507A	BARRA SLIDE/SWING 600mm	
CO.030508A	BARRA SLIDE/SWING 900mm	
CO.030509A	BARRA SLIDE/SWING 1200mm	
CO.030510	BARRA SLIDE/SWING 1800mm	
CO.030511	JUEGO ADAPTADOR VITRINA ALUMINIO 20*20	



### 03. PISTONES, SISTEMA DE APERTURA Y BISAGRAS

#### BISAGRAS FRENO GAMA ECO

##### BISAGRA RECTA 110° FRENO GAMA ECO

CÓDIGO	DESCRIPCIÓN	EMB. 100 UDS.
CO.0307F48F	BISAGRA CLICK RECTA CON FRENO 110° C.48 3D.	

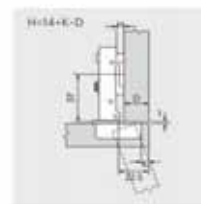

##### BISAGRA ACODADA FRENO GAMA ECO

CÓDIGO	DESCRIPCIÓN	EMB. 100 UDS.
CO.0307F48C8F	BISAGRA CLICK ACODADA FRENO CODO 8 C.48 3D.	

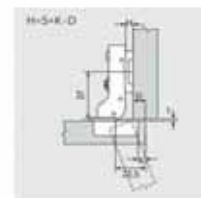

##### BISAGRA SUPERACODADA FRENO GAMA ECO

CÓDIGO	DESCRIPCIÓN	EMB. 100 UDS.
CO.0307F48C15F	BISAGRA CLICK SUPERACODADA FRENO CODO 15 C.48 3D.	



##### BISAGRA 180° FRENO GAMA ECO

CÓDIGO	DESCRIPCIÓN	EMB. 100 UDS.
CO.0307F48180F	BISAGRA CLIK 180° FRENO C.48 3D.	

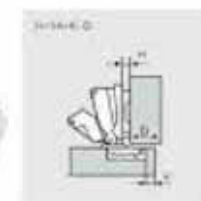

##### BISAGRA 90° RINCÓN BAJO FRENO GAMA ECO

CÓDIGO	DESCRIPCIÓN	EMB. 100 UDS.
CO.0307F4890F	BISAGRA CLIK RINCÓN BAJO 90° FRENO C.48 3D.	



##### BISAGRA 45° RINCÓN ALTO FRENO GAMA ECO

CÓDIGO	DESCRIPCIÓN	EMB. 100 UDS.
CO.0307F4845F	BISAGRA CLIK RINCÓN ALTO 45° FRENO C.48 3D.	

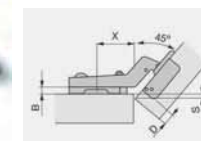

##### BASES FRENO GAMA ECO

CÓDIGO	DESCRIPCIÓN	EMB. 100 UDS.
CO.0308F00F	BASE CLIK FRENO 3D.	
CO.0308F00TF	BASE CLIK FRENO C/TACO 3D.	



The logo for COALFE, featuring a stylized teal 'C' composed of concentric, overlapping lines.

# COALFE<sup>®</sup>





Technik für Möbel

  
Hettich

## INTERMAT

#### BISAGRA INTERMAT RECTA 110°

EMB. 200 UDS.

CÓDIGO	DESCRIPCIÓN
CO.0307H45T	BISAGRA RECTA 110° C/TACO CENTRO 45
CO.0307H48T	BISAGRA RECTA 110° C/TACO CENTRO 48
CO.0307H52T	BISAGRA RECTA 110° C/TACO CENTRO 52
CO.0307H52	BISAGRA RECTA 110° S/TACO CENTRO 52

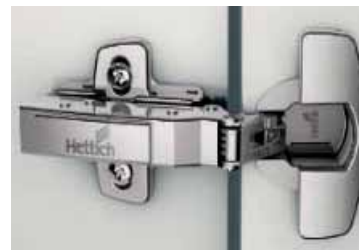

#### BISAGRA ACODADA

EMB. 200 UDS.

CÓDIGO	DESCRIPCIÓN
CO.0307H45C8T	BISAGRA ACODADA C/TACO CENTRO 45
CO.0307H48C8T	BISAGRA ACODADA C/TACO CENTRO 48
CO.0307H52C8T	BISAGRA ACODADA C/TACO CENTRO 52
CO.0307H52C8	BISAGRA ACODADA S/TACO CENTRO 52



#### BISAGRA SUPER ACODADA

EMB. 200 UDS.

CÓDIGO	DESCRIPCIÓN
CO.0307H45C1T	BISAGRA SUPERACODADA C/TACO CENTRO 45
CO.0307H48C1T	BISAGRA SUPERACODADA C/TACO CENTRO 48
CO.0307H52C1T	BISAGRA SUPERACODADA C/TACO CENTRO 52
CO.0307H52C1	BISAGRA SUPERACODADA S/TACO CENTRO 52



#### BISAGRA SENSYS 180° SIN FRENO

EMB. 50 UDS.

CÓDIGO	DESCRIPCIÓN
CO.0307H1804T	BISAGRA SENSYS 180° C/TACO CENTRO 45
CO.0307H18048T	BISAGRA SENSYS 180° C/TACO CENTRO 48
CO.0307H180T	BISAGRA SENSYS 180° C/TACO CENTRO 52
CO.0307H180	BISAGRA SENSYS 180° S/TACO CENTRO 52



#### BISAGRA INTERMAT RINCÓN BAJO 90°

EMB. 50 UDS.

CÓDIGO	DESCRIPCIÓN
CO.0307H90TB	BISAGRA RINCÓN BAJO 90° C/TACO CENTRO 45
CO.0307H90T4	BISAGRA RINCÓN BAJO 90° C/TACO CENTRO 48
CO.0307H90T	BISAGRA RINCÓN BAJO 90° C/TACO CENTRO 52
CO.0307H90	BISAGRA RINCÓN BAJO 90° S/TACO CENTRO 52



#### BISAGRA INTERMAT RINCO ALTO 45°

EMB. 50 UDS.

CÓDIGO	DESCRIPCIÓN
CO.0307H4545T	BISAGRA RINCÓN ALTO 45° C/TACO CENTRO 45
CO.0307H4548T	BISAGRA RINCÓN ALTO 45° C/TACO CENTRO 48
CO.0307H4552T	BISAGRA RINCÓN ALTO 45° C/TACO CENTRO 52
CO.0307H4552	BISAGRA RINCÓN ALTO 45° S/TACO CENTRO 52



## INTERMAT

## BISAGRA INTERMAT +30°

CÓDIGO	DESCRIPCIÓN	EMB. 50 UDS.
CO.0307H304T	BISAGRA +30° C/TACO CENTRO 45	
CO.0307H3048T	BISAGRA +30° C/TACO CENTRO 48	
CO.0307H30T	BISAGRA +30° C/TACO CENTRO 52	
CO.0307H30	BISAGRA +30° S/TACO CENTRO 52	



## BISAGRA INTERMAT DOBLE PUERTA

CÓDIGO	DESCRIPCIÓN	EMB. 50 UDS.
CO.0307H45RT	BISAGRA DOBLE PUERTA C/TACO CENTRO 45	
CO.0307H48RT	BISAGRA DOBLE PUERTA C/TACO CENTRO 48	
CO.0307H52RT	BISAGRA DOBLE PUERTA C/TACO CENTRO 52	
CO.0307H52R	BISAGRA DOBLE PUERTA S/TACO CENTRO 52	



## BISAGRA INTERMAT -45°

CÓDIGO	DESCRIPCIÓN	EMB. 50 UDS.
CO.0307H-45TB	BISAGRA -45° C/TACO CENTRO 45	
CO.0307H-45T	BISAGRA -45° C/TACO CENTRO 52	
CO.0307H-45	BISAGRA -45° S/TACO CENTRO 52	



## BISAGRA INTERMAT -30°

CÓDIGO	DESCRIPCIÓN	EMB. 50 UDS.
CO.0307H-30TB	BISAGRA -30° C/TACO CENTRO 45	
CO.0307H-30T	BISAGRA -30° C/TACO CENTRO 52	
CO.0307H-30	BISAGRA -30° S/TACO CENTRO 52	



## BISAGRA RECTA PUSH INTERMAT

CÓDIGO	DESCRIPCIÓN	EMB. 50 UDS.
CO.0307H52P	BISAGRA RECTA PUHS 110° S/TACO CENTRO 52	





## SENSYS

#### BISAGRA SENSYS RECTA SIN FRENO

CÓDIGO	DESCRIPCIÓN	EMB. 200 UDS.
CO.0307H45ST	BISAGRA SENSYS S/FRENO 110° C/TACO CENTRO 45	
CO.0307H48ST	BISAGRA SENSYS S/FRENO 110° C/TACO CENTRO 48	
CO.0307H52ST	BISAGRA SENSYS S/FRENO 110° C/TACO CENTRO 52	
CO.0307H52S	BISAGRA SENSYS S/FRENO 110° S/TACO CENTRO 52	



#### BISAGRA SENSYS RECTA CON FRENO

CÓDIGO	DESCRIPCIÓN	EMB. 200 UDS.
CO.0307H45FT	BISAGRA RECTA 110° C/TACO CENTRO 45 CON FRENO	
CO.0307H48FT	BISAGRA RECTA 110° C/TACO CENTRO 48 CON FRENO	
CO.0307H52FT	BISAGRA RECTA 110° C/TACO CENTRO 52 CON FRENO	
CO.0307H52F	BISAGRA RECTA 110° S/TACO CENTRO 52 CON FRENO	



#### BISAGRA SENSYS ACODADA CON FRENO

CÓDIGO	DESCRIPCIÓN	EMB. 200 UDS.
CO.0307H45C8FT	BISAGRA ACODADA C/TACO CENTRO 45 CON FRENO	
CO.0307H48C8FT	BISAGRA ACODADA C/TACO CENTRO 48 CON FRENO	
CO.0307H52C8FT	BISAGRA ACODADA C/TACO CENTRO 52 CON FRENO	
CO.0307H52C8F	BISAGRA ACODADA S/TACO CENTRO 52 CON FRENO	



#### BISAGRA SENSYS SUPER ACODADA CON FRENO

CÓDIGO	DESCRIPCIÓN	EMB. 50 UDS.
CO.0307H45C15FT	BISAGRA SUPERACODADA C/TACO CENTRO 45 CON FRENO	
CO.0307H48C15FT	BISAGRA SUPERACODADA C/TACO CENTRO 48 CON FRENO	
CO.0307H52C15FT	BISAGRA SUPERACODADA C/TACO CENTRO 52 CON FRENO	
CO.0307H52C15F	BISAGRA SUPERACODADA S/TACO CENTRO 52 CON FRENO	



#### BISAGRA SENSYS RINCÓN ALTO CON FRENO

CÓDIGO	DESCRIPCIÓN	EMB. 50 UDS.
CO.0307H4545FT	BISAGRA RINCÓN ALTO C/TACO CENTRO 45 CON FRENO	
CO.0307H4548FT	BISAGRA RINCÓN ALTO C/TACO CENTRO 48 CON FRENO	
CO.0307H4552FT	BISAGRA RINCÓN ALTO C/TACO CENTRO 52 CON FRENO	
CO.0307H4552F	BISAGRA RINCÓN ALTO S/TACO CENTRO 52 CON FRENO	



## BISAGRAS SENSYS

### BISAGRA SENSYS RINCÓN BAJO CON FRENO

CÓDIGO	DESCRIPCIÓN	EMB. 50 UDS.
CO.0307H904FT	BISAGRA RINCÓN BAJO C/TACO CENTRO 45 CON FRENO	
CO.0307H9048FT	BISAGRA RINCÓN BAJO C/TACO CENTRO 48 CON FRENO	
CO.0307H90FT	BISAGRA RINCÓN BAJO C/TACO CENTRO 52 CON FRENO	
CO.0307H90F	BISAGRA RINCÓN BAJO S/TACO CENTRO 52 CON FRENO	



### BISAGRA SENSYS 180° CON FRENO

CÓDIGO	DESCRIPCIÓN	EMB. 50 UDS.
CO.0307H184FT	BISAGRA 180° C/TACO CENTRO 45 CON FRENO	
CO.0307H1848FT	BISAGRA 180° C/TACO CENTRO 48 CON FRENO	
CO.0307H180FT	BISAGRA 180° C/TACO CENTRO 52 CON FRENO	
CO.0307H180F	BISAGRA 180° S/TACO CENTRO 52 CON FRENO	



### BISAGRA SENSYS RECTA PARA VITRINA CON FRENO

CÓDIGO	DESCRIPCIÓN	EMB. 50 UDS.
CO.0307HVF	BISAGRA RECTA PARA VITRINA S/TACO CENTRO 52 CON FRENO	



### BISAGRAS ESPECIALES PARA INTEGRAR FRIGORÍFICO

CÓDIGO	DESCRIPCIÓN	EMB. 10 UDS.
H.72134	BISAGRA FRIGO ET582 T22 C-SUP. 95°	
H.9239784	SET BISAGRA KAMAT FRIGORÍFICO	



## SENSYS OBSIDIAN BLACK

BISAGRA SENSYS RECTA 110° CON FRENO OBSIDIAN **EMB. 50 UDS.**

CÓDIGO	DESCRIPCIÓN
CO.0307H52FTN	BISAGRA CLICK RECTA FRENO HETTICH (SILENC SISTEM) C.52 ÓXIDO CON TETÓN
CO.0307H52PTN	BISAGRA CLICK RECTA PUSH HETTICH (SILENC SISTEM) C.52 ÓXIDO CON TETÓN



BISAGRA SENSYS 180° CON FRENO OBSIDIAN **EMB. 50 UDS.**

CÓDIGO	DESCRIPCIÓN
CO.0307H180FTN	BISAGRA CLICK HETTICH CON FRENO RINCÓN BAJO 180° ÓXIDO CON TETÓN. C.52



BISAGRA SENSYS RECTA PARA VITRINA CON FRENO OBSIDIAN

CÓDIGO	DESCRIPCIÓN
CO.0307HVFN	BISAGRA RECTA PARA VITRINA C.52 FRENO HETTICH ÓXIDO <b>EMB. 50 UDS.</b>



BISAGRA SENSYS 30° CON FRENO OBSIDIAN **EMB. 50 UDS.**

CÓDIGO	DESCRIPCIÓN
CO.0307H30FNT	BISAGRA CLICK 30° HETTICH C.52 CON FRENO ÓXIDO CON TETÓN



BISAGRA SENSYS 45° CON FRENO OBSIDIAN **EMB. 50 UDS.**

CÓDIGO	DESCRIPCIÓN
CO.0307H45FN	BISAGRA CLICK HETTICH CON FRENO RINCÓN BAJO 45° ÓXIDO. C.52



BISAGRA SENSYS 90° CON FRENO OBSIDIAN **EMB. 50 UDS.**

CÓDIGO	DESCRIPCIÓN
CO.0307H90FTN	BISAGRA CLICK HETTICH CON FRENO RINCÓN BAJO 90° ÓXIDO CON TETÓN. C.52



BISAGRA ACODADA OBSIDIAN **EMB. 50 UDS.**

CÓDIGO	DESCRIPCIÓN
CO.0307HC8FTN	BISAGRA CLICK HETTICH CON FRENO ACODADA ÓXIDO C.52



BISAGRA SUPER ACODADA OBSIDIAN **EMB. 50 UDS.**

CÓDIGO	DESCRIPCIÓN
CO.0307HC15FTN	BISAGRA CLICK HETTICH CON FRENO SUPER ACODADA ÓXIDO C.52



BASES SENSYS OBSIDIAN BLACK **EMB. 50 UDS.**

CÓDIGO	DESCRIPCIÓN
CO.0308H1TN	BASE CLICK BISG. FRENO CON EXCÉNTRICA TRES REGL. HETTICH TETÓN ÓXIDO
CO.0308H1TCN	BASE CLICK BISG. FRENO .CON EXCÉNTRICA TRES REGL. HETTICH TETÓN ALT. 0 ÓXIDO
H.9091818	BASE RECTA FRENO SENSYS CON TETÓN NEGRA



## ACCESORIOS

## BASES Y ACCESORIOS. BASES SENSYS

EMB. 200 UDS.

CÓDIGO	DESCRIPCIÓN
CO.0308H1	BASE BISAGRA SENSYS S/TACO
CO.0308H1L	BASE BISAGRA SENSYS ALTURA 0 C/TACO
CO.0308H1T	BASE BISAGRA SENSYS C/TACO
CO.0308H1T0	BASE BISAGRA SENSYS C/TACO 10
CO.0308H1TA	BASE BISAGRA SENSYS TORNILLO EURO



CÓDIGO	DESCRIPCIÓN	EMB. 50 UDS.
H.9082612	TAPA BRAZO BISAGRA SENSYS NEUTRO	
H.9082774	TAPA BRAZO BISAGRA SENSYS LOGO HETTICH	



CÓDIGO	DESCRIPCIÓN	EMB. 50 UDS.
H.9082614	TAPA CAZOLETA SENSYS 52	
H.9084924	TAPA CAZOLETA SENSYS 45	



CÓDIGO	DESCRIPCIÓN	EMB. 50 UDS.
H.9091821	TAPA BRAZO SENSYS "HETTICH FLASH" UE200 ÓXIDO	



CÓDIGO	DESCRIPCIÓN	EMB. 50 UDS.
H.9091822	TAPA CAZOLETA SENSYS "HETTICH FLASH" UE200 ÓXIDO	



CÓDIGO	DESCRIPCIÓN	EMB. 50 UDS.
CO.0307HP-A	EXPULSADOR IMÁN PARA BISAGRA PUSH HETTICH	
CO.0307HP-C	IMÁN PLACA IMÁN PARA BISAGRA PUSH HETTICH	
CO.0307HP-B	SOPORTE DEL ESPULSADOR PARA BISABRA	



CÓDIGO	DESCRIPCIÓN	EMB. 50 UDS.
H.9090864	LIMITADOR APERTURA 90-135 PARA BISAGRA SENSYS 180°	



CÓDIGO	DESCRIPCIÓN	EMB. 50 UDS.
H.9100037	AMORTIGUACION APERTURA 90-135 PARA BISAGRA SENSYS 180°	



#### BISAGRAS CORNER

##### BISAGRAS RINCOBASIC - RINCOPLUS

EMB. 1 UD.

CÓDIGO	DESCRIPCIÓN
CO.03RB7001	BISAGRA RINCOBASIC40 BLANCA 70
CO.03RB7006	BISAGRA RINCOBASIC40 ALUMINIO MATE 70
CO.03RB7002	BISAGRA RINCOBASIC40 ALUMINIO INOX 70
CO.03RB8001	BISAGRA RINCOBASIC40 BLANCA 80
CO.03RB8006	BISAGRA RINCOBASIC40 ALUMINIO MATE 80
CO.03RB8002	BISAGRA RINCOBASIC40 ALUMINIO INOX 80
CO.03RB9001	BISAGRA RINCOBASIC40 BLANCA 90
CO.03RB9006	BISAGRA RINCOBASIC40 ALUMINIO MATE 90
CO.03RB9002	BISAGRA RINCOBASIC40 ALUMINIO INOX 90
CO.03RP7001	BISAGRA RINCOPLUS40 BLANCA 70
CO.03RP7006	BISAGRA RINCOPLUS40 ALUMINIO MATE 70
CO.03RP7002	BISAGRA RINCOPLUS40 ALUMINIO INOX 70
CO.03RP8001	BISAGRA RINCOPLUS40 BLANCA 80
CO.03RP8006	BISAGRA RINCOPLUS40 ALUMINIO MATE 80
CO.03RP8002	BISAGRA RINCOPLUS40 ALUMINIO INOX 80
CO.03RP9001	BISAGRA RINCOPLUS40 BLANCA 90
CO.03RP9006	BISAGRA RINCOPLUS40 ALUMINIO MATE 90
CO.03RP9002	BISAGRA RINCOPLUS40 ALUMINIO INOX 90
	<b>DISPONIBLES EN NEGRO, NEGRO MATE Y BLANCO MATE</b>



##### BISAGRAS CORNER

EMB. 1 UD.

CÓDIGO	DESCRIPCIÓN
CO.03067006	BISAGRA CORNER 70 CROMO MATE
CO.03069006	BISAGRA CORNER 90 CROMO MATE
CO.03067002	BISAGRA CORNER 70 INOX
CO.03069002	BISAGRA CORNER 90 INOX
CO.03067004	BISAGRA CORNER 70 BRONCE
CO.03069004	BISAGRA CORNER 90 BRONCE





EXPULSADORES PARA PUERTAS

CÓDIGO	DESCRIPCIÓN
CO.0309F00	EXPULSADOR CON GOMA PARA CAJÓN
CO.0309F01	EXPULSADOR CON GOMA PARA PUERTA

EXPULSADOR CON GOMA PARA CAJÓN



EXPULSADOR CON GOMA PARA PUERTA



EXPULSADOR K-PUSH TECH (IMÁN/EMBUTIDO)

EMB. 100 UD.

CÓDIGO	DESCRIPCIÓN
D.0287320	EXPULSADOR K-PUSH TECH MEDIO IMAN STRONG GRIS
D.0287520	EXPULSADOR K-PUSH TECH LARGO IMAN STRONG GRIS
D.0200307	EXPULSADOR K-PUSH TECH LARGO IMAN STRONG ANTRACITA
D.0287401	EXPULSADOR K-PUSH TECH LARGO IMAN STRONG BLANCO
D.0287720	EXPULSADOR K-PUSH TECH LARGO IMAN GRIS



EXPULSADOR K-PUSH TECH (GOMA/EMBUTIDO)

EMB. 100 UD.

CÓDIGO	DESCRIPCIÓN
D.0287420	EXPULSADOR K-PUSH TECH MEDIO GOMA STRONG GRIS
D.0287620	EXPULSADOR K-PUSH TECH LARGO GOMA STRONG GRIS
D.0200207	EXPULSADOR K-PUSH TECH LARGO GOMA STRONG ANTRACITA
D.0287301	EXPULSADOR K-PUSH TECH LARGO GOMA STRONG BLANCO
D.0287820	EXPULSADOR K-PUSH TECH LARGO GOMA GRIS



EXPULSADORES

BASE EXPULSADOR K-PUSH TECH

EMB. 100 UD.

CÓDIGO	DESCRIPCIÓN
D.0287020	BASE EXPULSADOR K-PUSH TECH MEDIO GRIS
D.0287120	BASE EXPULSADOR K-PUSH TECH LARGO GRIS
D.0200107	BASE EXPULSADOR K-PUSH TECH LARGO ANTRACITA
D.0287201	BASE EXPULSADOR K-PUSH TECH LARGO BLANCO
D.0240193	PLACA ADHESIVA



EXPULSADORES PUSLATCH

CÓDIGO	DESCRIPCIÓN	EMB. 100 UDS.
E.1908321	CIERRE PUSLATCH44 EMB REG D10	EMB. 100 UDS.
E.1908221	SOP PUSHLATCHCH40 GR	EMB. 100 UDS.
E.1908421	CIERRE MAGNÉTICO EMB REG D10	EMB. 100 UDS.
D.0240193	PLACA ADHESIVA	EMB. 100 UDS.



EXPULSADORES

CÓDIGO	DESCRIPCIÓN	EMB. 200 UD.
CO.0309F01T	EXPULSADOR CON GOMA PARA PUERTA. TITUS	EMB. 200 UD.
CO.0309F01TI	EXPULSADOR CON IMÁN PARA PUERTA. TITUS + PLACA ADHESIVA	EMB. 200 UD.



## 04. VITRINAS

### S. VITRINAS MODELO SEVILLA

SEVILLA	30	35	40	45	50	60
60	S.60*30	S.60*35	S.60*40	S.60*45	S.60*50	S.60*60
70	S.70*30	S.70*35	S.70*40	S.70*45	S.70*50	S.70*60
80	S.80*30	S.80*35	S.80*40	S.80*45	S.80*50	S.80*60
90	S.90*30	S.90*35	S.90*40	S.90*45	S.90*50	S.90*60
120	S.120*30	S.120*35	S.120*40	S.120*45	S.120*50	S.120*60

### S. VITRINAS MODELO SEVILLA CON CRISTAL MATE

SEVILLA CRISTAL MATE	30	35	40	45	50	60
60	S.60*30CM	S.60*35CM	S.60*40CM	S.60*45CM	S.60*50CM	S.60*60CM
70	S.70*30CM	S.70*35CM	S.70*40CM	S.70*45CM	S.70*50CM	S.70*60CM
80	S.80*30CM	S.80*35CM	S.80*40CM	S.80*45CM	S.80*50CM	S.80*60CM
90	S.90*30CM	S.90*35CM	S.90*40CM	S.90*45CM	S.90*50CM	S.90*60CM
120	S.120*30CM	S.120*35CM	S.120*40CM	S.120*45CM	S.120*50CM	S.120*60CM

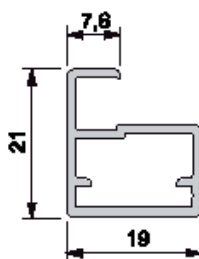

OTRAS MEDIDAS Y MODELOS CONSULTAR,  
BISAGRAS NO INCLUIDAS

### M. VITRINAS MODELO MÁLAGA

MÁLAGA	30	35	40	45	50	60
60	M.60*30	M.60*35	M.60*40	M.60*45	M.60*50	M.60*60
70	M.70*30	M.70*35	M.70*40	M.70*45	M.70*50	M.70*60
80	M.80*30	M.80*35	M.80*40	M.80*45	M.80*50	M.80*60
90	M.90*30	M.90*35	M.90*40	M.90*45	M.90*50	M.90*60
120	M.120*30	M.120*35	M.120*40	M.120*45	M.120*50	M.120*60

### M. VITRINAS MODELO MÁLAGA CON CRISTAL MATE

MÁLAGA CRISTAL MATE	30	35	40	45	50	60
60	M.60*30CM	M.60*35CM	M.60*40CM	M.60*45CM	M.60*50CM	M.60*60CM
70	M.70*30CM	M.70*35CM	M.70*40CM	M.70*45CM	M.70*50CM	M.70*60CM
80	M.80*30CM	M.80*35CM	M.80*40CM	M.80*45CM	M.80*50CM	M.80*60CM
90	M.90*30CM	M.90*35CM	M.90*40CM	M.90*45CM	M.90*50CM	M.90*60CM
120	M.120*30CM	M.120*35CM	M.120*40CM	M.120*45CM	M.120*50CM	M.120*60CM

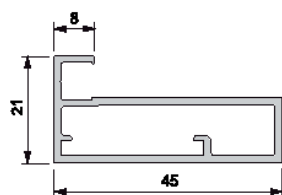

OTRAS MEDIDAS Y MODELOS CONSULTAR,  
BISAGRAS NO INCLUIDAS



### C. VITRINAS MODELO JAÉN

JAÉN	30	35	40	45	50	60
60	J.60*30	J.60*35	J.60*40	J.60*45	J.60*50	J.60*60
70	J.70*30	J.70*35	J.70*40	J.70*45	J.70*50	J.70*60
80	J.80*30	J.80*35	J.80*40	J.80*45	J.80*50	J.80*60
90	J.90*30	J.90*35	J.90*40	J.90*45	J.90*50	J.90*60
120	J.120*30	J.120*35	J.120*40	J.120*45	J.120*50	J.120*60

JAÉN CON CRISTAL	30	35	40	45	50	60
60	J.60*30CM	J.60*35CM	J.60*40CM	J.60*45CM	J.60*50CM	J.60*60CM
70	J.70*30CM	J.70*35CM	J.70*40CM	J.70*45CM	J.70*50CM	J.70*60CM
80	J.80*30CM	J.80*35CM	J.80*40CM	J.80*45CM	J.80*50CM	J.80*60CM
90	J.90*30CM	J.90*35CM	J.90*40CM	J.90*45CM	J.90*50CM	J.90*60CM
120	J.120*30CM	J.120*35CM	J.120*40CM	J.120*45CM	J.120*50CM	J.120*60CM

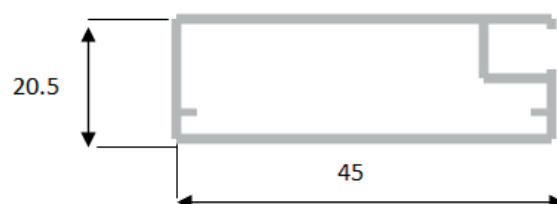

OTRAS MEDIDAS Y MODELOS CONSULTAR, BISAGRAS NO INCLUIDAS

### V. VITRINAS MODELO VINTAGE

VINTAGE	30	35	40	45	50	60
60	V.60*30	V.60*35	V.60*40	V.60*45	V.60*50	V.60*60
70	V.70*30	V.70*35	V.70*40	V.70*45	V.70*50	V.70*60
80	V.80*30	V.80*35	V.80*40	V.80*45	V.80*50	V.80*60
90	V.90*30	V.90*35	V.90*40	V.90*45	V.90*50	V.90*60
120	V.120*30	V.120*35	V.120*40	V.120*45	V.120*50	V.120*60

VINTAGE CRISTAL MATE	30	35	40	45	50	60
60	V.60*30CM	V.60*35CM	V.60*40CM	V.60*45CM	V.60*50CM	V.60*60CM
70	V.70*30CM	V.70*35CM	V.70*40CM	V.70*45CM	V.70*50CM	V.70*60CM
80	V.80*30CM	V.80*35CM	V.80*40CM	V.80*45CM	V.80*50CM	V.80*60CM
90	V.90*30CM	V.90*35CM	V.90*40CM	V.90*45CM	V.90*50CM	V.90*60CM
120	V.120*30CM	V.120*35CM	V.120*40CM	V.120*45CM	V.120*50CM	V.120*60CM

OTRAS MEDIDAS Y MODELOS CONSULTAR, BISAGRAS NO INCLUIDAS



## 05. ELEMENTOS LINEALES Y PERSIANAS

### COPETE GORBEA

### COPETES Y ACCESORIOS

CÓDIGO	DESCRIPCIÓN	EMB. 20 UDS.
CO.05010101	COPETE 4M. LACADO EN BLANCO	
CO.05010103	COPETE 4M. LACADO EN NEGRO	
CO.05010107	COPETE 4M. LACADO EN BRONCE	
CO.05010108	COPETE 4M. LACADO EN PLATA	



CÓDIGO	DESCRIPCIÓN	EMB. 25 UDS.
CO.05010201	RINCONERA COPETE BLANCO	
CO.05010203	RINCONERA COPETE NEGRO	
CO.05010207	RINCONERA COPETE BRONCE	
CO.05010208	RINCONERA COPETE PLATA	



CÓDIGO	DESCRIPCIÓN	EMB. 25 UDS.
CO.05010301	ESQUINERA COPETE BLANCO	
CO.05010303	ESQUINERA COPETE NEGRO	
CO.05010307	ESQUINERA COPETE BRONCE	
CO.05010308	ESQUINERA COPETE PLATA	



CÓDIGO	DESCRIPCIÓN	EMB. 100 UDS.
CO.050104D01	TAPA DERECHA COPETE BLANCO	
CO.050104D03	TAPA DERECHA COPETE NEGRO	
CO.050104D07	TAPA DERECHA COPETE BRONCE	
CO.050104D08	TAPA DERECHA COPETE PLATA	
CO.050104I01	TAPA IZQUIERDA COPETE BLANCO	
CO.050104I03	TAPA IZQUIERDA COPETE NEGRO	
CO.050104I07	TAPA IZQUIERDA COPETE BRONCE	
CO.050104I08	TAPA IZQUIERDA COPETE PLATA	



### COPETE MIXLINE

CÓDIGO	DESCRIPCIÓN	EMB. 10 UDS.
E.8914463	COPETE 4M. MIXLINE GRIS	
E.8914521	KIT ACCESORIOS COPETE MIXLINE GRIS	



### COPETE D-7

CÓDIGO	DESCRIPCIÓN	EMB. 30 UDS.
D.0500791	COPETE D7 INOX A 4 ML.	
D.0500891	KIT ACCESORIOS COPETE D7 INOX	



### COPETE D-8

CÓDIGO	DESCRIPCIÓN	EMB. 30 UDS.
D.0890287	COPETE D8 PVC ALUMINIO CEPILLADO 4 ML.	
D.0890101	COPETE D8 PVC BLANCO 4 ML.	
D.0501607	COPETE D8 PVC NEGRO MATE 4 ML.	
D.0890320	KIT ACCESORIOS COPETE D8 GRIS	
D.0890201	KIT ACCESORIOS COPETE D8 BLANCO	
D.0501707	KIT ACCESORIOS COPETE D8 NEGRO MATE	

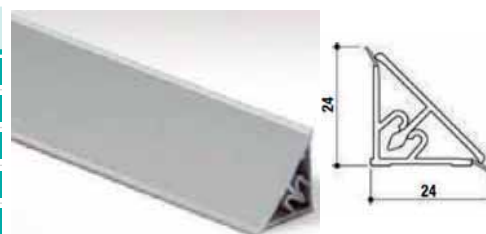

### COPETE CURVO

CÓDIGO	DESCRIPCIÓN	EMB. 30 UDS.
CO.05010108A	COPETE ALUMINIO CURVO D3 PLATA MATE TIRA DE 4M.	
CO.05010208A	RINCÓN COPETE CURVO D3 PLATA MATE	
CO.05010308A	ESQUINA COPETE CURVO D3 PLATA MATE	
CO.050104D08A	TAPA COPETE PLATA MATE D3	



## 05. ELEMENTOS LINEALES Y PERSIANAS

### ZÓCALOS Y ACCESORIOS

#### ZÓCALOS ALUMINIO A 4 METROS

EMB. 16 UDS.

ALTURA	100 MM	145 MM	170 MM
BLANCO	CO.0502010B	CO.0502014B	CO.0502017B
NEGRO		CO.0502014N	
BRONCE		CO.0502014BR	
PLATA	CO.0502010P	CO.0502014P	CO.0502017P
ANTRACITA	CO.0502010ANT	CO.0502014ANT	



#### ZÓCALOS PVC 4 METROS

EMB. 15 UDS.

ALTURA	100 MM	145 MM	170 MM
BLANCO	CO.0502010PVCB	CO.0502014PVCB	
NEGRO	CO.0502010PVCN	CO.0502014PVCN	
ALUMINIO CEPILLADO	CO.0502010PVCAC	CO.0502014PVCAC	CO.0502017PVCAC



#### ACCESORIO FLEXIBLE ZÓCALO ALUMINIO

EMB. 20 UDS.

ALTURA	100 MM	145 MM	170 MM
BLANCO	CO.0502010BAC	CO.0502014BAC	CO.0502017BAC
NEGRO		CO.0502014NAC	
BRONCE		CO.0502014BRAC	
PLATA	CO.0502010PAC	CO.0502014PAC	CO.0502017PAC
ANTRACITA	CO.0502010ANTAC	CO.0502014ANTAC	



#### ACCESORIO FLEXIBLE ZÓCALO PVC LAMINADO

EMB. 20 UDS.

ALTURA	100 MM	145 MM	170 MM
BLANCO	CO.0502010PVCBAC	CO.0502014PVCBAC	
NEGRO	CO.0502010PVCNAC	CO.0502014PVCNAC	
ALUMINIO CEPILLADO	CO.0502010PVCACAC	CO.0502014PVCACAC	CO.0502017PVCACAC



#### PERFIL ANTIHUMEDAD

CÓDIGO	DESCRIPCIÓN	
CO.050204	PROTECTOR ANTIHUMEDAD 19MM TIRA 3,60 M CRISTAL	100 UDS.
CO.050204A	PROTECTOR ANTIHUMEDAD 22MM TIRA 3,60 M CRISTAL	90 UDS.



## 05. ELEMENTOS LINEALES Y PERSIANAS

### PERFIL VITRINA Y ACESORIOS

CÓDIGO	DESCRIPCIÓN	EMB. 75 UDS.
CO.05030101	PERFIL VITRINA ADHESIVO 3M. BLANCO	
CO.05030108	PERFIL VITRINA ADHESIVO 3M. PLATA	
CO.05030106	PERFIL VITRINA ADHESIVO 3M. CROMO MATE	



CÓDIGO	DESCRIPCIÓN	EMB. 400 UDS.
CO.05030201	ÁNGULO PERFIL VITRINA BLANCO	
CO.05030208	ÁNGULO PERFIL VITRINA PLATA	
CO.05030206	ÁNGULO PERFIL VITRINA CROMO MATE	

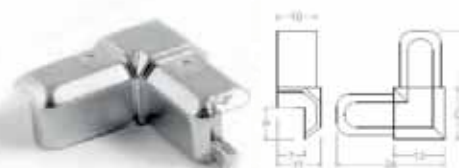

#### ACCESORIOS ENCIMERAS 2R10 30MM.

CÓDIGO	DESCRIPCIÓN	EMB. 50 UDS.
CO.05040101	TAPA ENCIMERA 2R10 DE 30MM. BLANCO	
CO.05040103	TAPA ENCIMERA 2R10 DE 30MM. NEGRO	
CO.05040107	TAPA ENCIMERA 2R10 DE 30MM. BRONCE	
CO.05040108	TAPA ENCIMERA 2R10 DE 30MM. PLATA	



CÓDIGO	DESCRIPCIÓN	EMB. 50 UDS.
CO.05040201	T-DESPLAZADA 2R10 DE 30MM. BLANCO	
CO.05040203	T-DESPLAZADA 2R10 DE 30MM. NEGRO	
CO.05040207	T-DESPLAZADA 2R10 DE 30MM. BRONCE	
CO.05040208	T-DESPLAZADA 2R10 DE 30MM. PLATA	



CÓDIGO	DESCRIPCIÓN	EMB. 50 UDS.
CO.05040301	T-RECTA 2R10 DE 30MM. BLANCO	
CO.05040303	T-RECTA 2R10 DE 30MM. NEGRO	
CO.05040307	T-RECTA 2R10 DE 30MM. BRONCE	
CO.05040308	T-RECTA 2R10 DE 30MM. PLATA	



#### ACCESORIOS ENCIMERAS 2R10 40MM.

CÓDIGO	DESCRIPCIÓN	EMB. 50 UDS.
CO.05040101A	TAPA ENCIMERA CUADRADA 40MM. BLANCO	
CO.05040108M	TAPA ENCIMERA CUADRADA 40MM. PLATA MATE	
CO.05040108A	TAPA ENCIMERA CUADRADA 40MM. PLATA BRILLO	

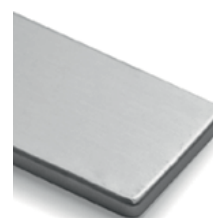

CÓDIGO	DESCRIPCIÓN	EMB. 50 UDS.
CO.05040201A	T-DESPLAZADA CUADRADA 40MM. BLANCO	
CO.05040208M	T-DESPLAZADA CUADRADA 40MM. PLATA MATE	
CO.05040208A	T-DESPLAZADA CUADRADA 40MM. PLATA BRILLO	



CÓDIGO	DESCRIPCIÓN	EMB. 50 UDS.
CO.05040301A	T-RECTA CUADRADA 40MM. BLANCO	
CO.05040308M	T-RECTA CUADRADA 40MM. PLATA MATE	
CO.05040308A	T-RECTA CUADRADA 40MM. PLATA BRILLO	



## 05. ELEMENTOS LINEALES Y PERSIANAS



### PERSIANAS

#### KIT PERSIANA BASICA

CÓDIGO	DESCRIPCIÓN	MEDIDAS
CO.05050160	KIT PERSIANA PVC. Color INOX	60 x 130 cm.
CO.05050160A	KIT PERSIANA PVC. Color INOX	60 x 150 cm.
CO.05050190	KIT PERSIANA PVC. Color INOX	90 x 150 cm.
CO.05050160B	KIT PERSIANA PVC. Color BLANCA	60 x 150 cm.
CO.05050190B	KIT PERSIANA PVC. Color BLANCA	90 x 150 cm.
CO.05050160P	KIT PERSIANA PVC. Color PIZARRA/ ANTRACITA	60 x 150 cm.
CO.05050190P	KIT PERSIANA PVC. Color PIZARRA/ ANTRACITA	90 x 150 cm.
CO.05050160C	KIT PERSIANA PVC. Color CARBONO	60 x 150 cm.
CO.05050190C	KIT PERSIANA PVC. Color CARBONO	90 x 150 cm.
CO.05050160N	KIT PERSIANA PVC. Color NEGRO	60 x 150 cm.
CO.05050190N	KIT PERSIANA PVC. Color NEGRO	90 x 150 cm.

DISPONIBLES EN LOS COLORES ARRIBA REFERENCIADOS Y PARA CASCO DE 16 Y 19 MM



INOX



BLANCA



PIZARRA



CARBONO



NEGRO

#### KIT PERSIANA HIGH GLOSS

CÓDIGO	DESCRIPCIÓN	MEDIDAS
CO.05050560	KIT PERSIANA. Color Blanco Alto Brillo	60 x 150 cm.
CO.05050590	KIT PERSIANA. Color Blanco Alto Brillo	90 x 150 cm.



#### KIT PERSIANA MICROPERFORADA

CÓDIGO	DESCRIPCIÓN	MEDIDAS
CO.05050660	KIT PERSIANA PVC. Color TITANIO Microperforada	60 x 150 cm.
CO.05050690	KIT PERSIANA PVC. Color TITANIO Microperforada	90 x 150 cm.

DISPONIBLES PARA CASCO DE 16 Y 19 M



### PERSIANAS

#### PERSIANA DE CRISTAL

CÓDIGO	DESCRIPCIÓN	MEDIDAS
CO.05050VIDRIO	PERSIANA DE LAMAS DE CRISTAL	150 x 60 cm.
CO.05050VIDRIOA	PERSIANA DE LAMAS DE CRISTAL	150 x 90 cm.
	DISPONIBLES EN NEGRO Y BLANCO	



#### CANTOS TERMOPLÁSTICOS

GAMA CANTOS PREENCOLADOS Y MAQUINA DE 19 MM Y 22MM Y ACRILICOS 23 MM DE MULTITUD DE COLORES.

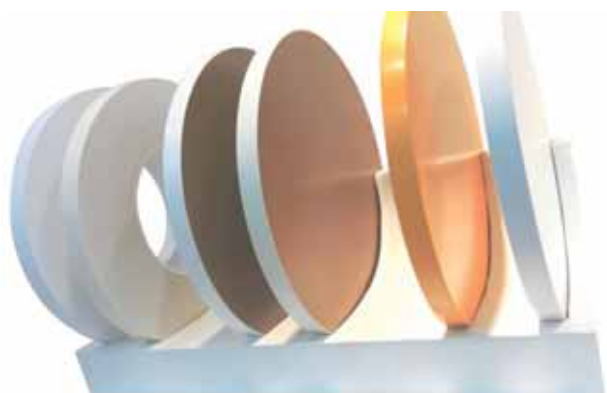

#### CANTOS PREENCOLADOS PARA PLANCHAS

CÓDIGO	DESCRIPCIÓN
CO.BLANCO SOFT	CANTO MELAMINA BLANCO SOFT DE 0.4*22 PREENCOLADO
CO.ALUMI-TRIANA	CANTO MELAMINA ALUMINIO TRIANA DE 0.4*19 PREENCOLADO



## 05. ELEMENTOS LINEALES Y PERSIANAS



### ADHESIVOS PROFESIONALES

CÓDIGO	DESCRIPCIÓN	ENVASE
TE25-1T	Termocol <b>1T</b> termofusible invisible	Saco 25 Kg.
TE10-1T		Cubo 10 Kg.
TE25-2N	Termocol <b>2N</b> termofusible universal natural	Saco 25 Kg.
TE10-2N		Cubo 10 Kg.
TE25-2B	Termocol <b>2B</b> termofusible universal blanca	Saco 25 Kg.
TE10-2B		Cubo 10 Kg.
TE25-2NG	Termocol <b>2NG</b> termofusible universal negra	Saco 25 Kg.
TE25-3N	Termocol <b>3N</b> termofusible alta fusión natural	Saco 25 Kg.
TE25-3B	Termocol <b>3B</b> termofusible alta fusión blanca	Saco 25 Kg.
TE25-4N	Termocol <b>4N</b> termofusible manual y preen. natural	Saco 25 Kg.
TE15-5N	Termocol <b>5N</b> termofusible cartucho Holzher natural	Caja 15 Kg.
TE11-5T	Termocol <b>5T</b> termofusible cartucho Holzher invisible	Caja 11 Kg.
VI25-50U	Cola blanca universal de alta resistencia <b>D2</b>	Cubo 25 Kg.
VI5-50U		Cubo 5 Kg.
VI075-50U		Bote 750 g.
VI25-51R	Cola blanca rápida resistente a la humedad <b>D3</b>	Cubo 25 Kg.
VI5-51R		Cubo 5 Kg.
VI075-51R		Bote 750 g.
VI25-52R	Cola de montaje rápida amarilla <b>D2</b>	Cubo 25 Kg.
VI5-52R		Cubo 5 Kg.
VI075-52R		Bote 750 g.
VI25-53SR	Cola blanca rápida de montaje express	Cubo 25 Kg.
VI5-53SR		Cubo 5 Kg.
VI075-53SR		Bote 750 g.
10AC1-1A	Limpiador líq. de adhesivos en acrílicos. Aerosol 400 cc	Bote 400 cc.
10AC3-1G	Limpiador líquido de adhesivos en acrílicos	Garrafa 5 l.
10AC2-1G	Limpiador líquido de adhesivos en acrílicos	Garrafa 25 l.
10AC1-2A	Limpiador líq. de adhesivos en acrílicos. Aerosol 50 cc.	Bote 50 cc.



## 06. EQUIPAMIENTO DE COCINAS

### EQUIPAMIENTOS DE COCINA

#### MARCOS MICROONDAS UNIVERSAL

EMB. 14 UDS.

CÓDIGO	DESCRIPCIÓN
CO.060101	MARCOS MICROONDAS BLANCO
CO.060103	MARCOS MICROONDAS NEGRO
CO.060104	MARCOS MICROONDAS MARRÓN
CO.060106	MARCOS MICROONDAS INOX



#### REJILLAS DE AIREACIÓN FRIGORÍFICO

EMB. 20 UDS.

CÓDIGO	DESCRIPCIÓN
CO.06020201	REJILLAS AIREACIÓN FRIGORÍFICO 8 VARILLAS BLANCO.60
CO.06020203	REJILLAS AIREACIÓN FRIGORÍFICO 8 VARILLAS NEGRO.60
CO.06020204	REJILLAS AIREACIÓN FRIGORÍFICO 8 VARILLAS BRONCE.60
CO.06020202	REJILLAS AIREACIÓN FRIGORÍFICO 8 VARILLAS INOX.60
CO.06029001	REJILLAS AIREACIÓN FRIGORÍFICO 8 VARILLAS 90 BLANCA
CO.06029002	REJILLAS AIREACIÓN FRIGORÍFICO 8 VARILLAS 90 INOX
CO.06029003	REJILLAS AIREACION FRIGORIFICO 8 VARILLAS 90 NEGRO
CO.060212002	REJILLAS AIREACIÓN FRIGORÍFICO 8 VARILLAS 120 INOX
CO.060212003	REJILLAS AIREACION FRIGORIFICO 8 VARILLAS 120 NEGRO
CO.060212001	REJILLAS AIREACIÓN FRIGORÍFICO 8 VARILLAS 120 BLANCA



CÓDIGO	DESCRIPCIÓN	EMB. 10 UDS.
CO.0602Z03	REJILLA ZÓCALO NEGRO 70*450	
CO.0602Z01	REJILLA ZÓCALO BLANCO 70*450	
CO.0602Z06	REJILLA ZÓCALO CROMO MATE 70*450	
CO.0602Z08	REJILLA ZÓCALO NÍQUEL CEPILLADO 450*70	



CÓDIGO	DESCRIPCIÓN	EMB. 10 UDS.
CO.0602036002	REJILLA PARA VITROCERAMICA INDUCCIÓN MOD.60 INOX ALT 32 MM	
CO.0602039002	REJILLA PARA VITROCERAMICA INDUCCIÓN MOD.90 INOX ALT 32 MM	
CO.0602036002-A	REJILLA PARA VITROCERAMICA INDUCCIÓN MOD.60 INOX ALT 20 MM	
CO.0602039002-A	REJILLA PARA VITROCERAMICA INDUCCIÓN MOD.90 INOX ALT 20 MM	



#### LATERALES CAMPANA

EMB. 1 UD.

CÓDIGO	DESCRIPCIÓN
CO.060401	JUEGO LATERAL CAMPANA 235*330 BLANCO
CO.060402	JUEGO LATERAL CAMPANA 235*330 INOX MATE



#### PERFIL REFUERZO DELANTERO Y TRASERO

CÓDIGO	DESCRIPCIÓN	EMB.
CO.06050145	REFUERZO MUEBLE PLATERO-FREGADERO MOD.45	10 UDS.
CO.06050150	REFUERZO MUEBLE PLATERO-FREGADERO MOD.50	10 UDS.
CO.06050160	REFUERZO MUEBLE PLATERO-FREGADERO MOD.60	10 UDS.
CO.06050170	REFUERZO MUEBLE PLATERO-FREGADERO MOD.70	10 UDS.
CO.06050180	REFUERZO MUEBLE PLATERO-FREGADERO MOD.80	10 UDS.
CO.06050190	REFUERZO MUEBLE PLATERO-FREGADERO MOD.90	10 UDS.
CO.060501100	REFUERZO MUEBLE PLATERO-FREGADERO MOD.100	10 UDS.
CO.060501120	REFUERZO MUEBLE PLATERO-FREGADERO MOD.120	10 UDS.
CO.060501	BARRA REFUERZO MUEBLE PLATERO-FREGADERO 3 ML.	10 UDS.
CO.060502	SOPORTE REFUERZO ATORNILLAR	100 UDS.



#### PERFIL PLÁSTICO CUBRE COSTADO

CÓDIGO	DESCRIPCIÓN	EMB. 10 UDS.
CO.0608	PERFIL PLAST. CUBRE COSTADO DE 17 MM PL. TIRA 2,50 METROS INOX	
CO.0608C	TAPA PL DE PERFIL CUBRE COSTADO DE 19 MM	25 UDS.
CO.0608A	TAPA PL DE PERFIL CUBRE COSTADO DE 22 MM	25 UDS.
CO.0608D	TAPA PL DE PERFIL CUBRE COSTADO DE 25 MM	25 UDS.
CO.0608B	TAPA PL DE PERFIL CUBRE COSTADO DE 40 MM	25 UDS.





## 07. PATAS, COLGADORES, SOPORTES, TOPES

### PEGAMENTOS DE UNIÓN Y SILICONAS

#### PATA SICILIA

CÓDIGO	DESCRIPCIÓN	
CO.070101	PATA EXPANSIVAS ALTURA 15	EMB. 200 UDS.
CO.070101A	PATA EXPANSIVAS ALTURA 10	EMB. 200 UDS.



#### PATA TOSCANA

CÓDIGO	DESCRIPCIÓN	
CO.070105	PATA MODELO TOSCANA P/GUIADOR DE 13-20 MM	EMB. 120 UDS.
CO.070105A	PATA MODELO TOSCANA P/GUIADOR DE 10-13 MM	EMB. 160 UDS.



#### PATA ELEFANT

CÓDIGO	DESCRIPCIÓN	
HF.63781375	VERSTELLEIL SCHW. 78*150 MM	EMB. 150 UDS.
HF.63781372	VERSTELLEIL SCHW. 78*100 MM	
HF.63781301	ADAPTADOR PLTA DIMET 78 PARA ATORNILLAR	
HF.63781309	ADAPTADOR PLTA DIMET 78 CON TETÓN	



#### PATA SMART

CÓDIGO	DESCRIPCIÓN	
D.0701407	SET 4 PATAS SMART ALTURA H6 (60-80)	EMB. 25 UDS.
D.0701507	SET 4 PATAS SMART ALTURA H8 (80-100)	EMB. 25 UDS.
D.0603396	DESTORNILLADOR PARA REGULACIÓN FRONTAL	EMB. 1 UD.



#### PINZAS

CÓDIGO	DESCRIPCIÓN	
CO.070109A	PINZA ZOCALO PVC	EMB. 1000 UDS.
CO.070109	PINZA DE ZÓCALO PARA ALUMINIO Y MADERA	EMB. 2800 UDS.
CO.070109B	PINZA DE ZOCALO PARA ALUMINIO Y MADERA. PATA ERCOLINO Y ELEFANT	EMB. 50 UDS.
D.0621298	PINZA EASY PARA ZÓCALO	EMB. 50 UDS.



# PATAS DECORATIVAS

## PATAS DECORATIVAS

CÓDIGO	DESCRIPCIÓN	
CO.070107	PATA ALUMINIO CUADRADA DE 15 40*40 C/REGULACIÓN	EMB. 24 UDS.
CO.070107X	PATA ALUMINIO CUADRADA DE 15 40*40 C/REG. INOX	EMB. 24 UDS.
CO.070106	PATA ALUMINIO REDONDA ALTURA REG. 140-170	EMB. 16 UDS.
CO.070106X	PATA ALUMINIO REDONDA ALTURA REG.140-170 INOX	EMB. 16 UDS.
	DISPONIBLES DIFERENTES ACABADOS	



CÓDIGO	DESCRIPCIÓN	EMB. 10 UDS.
CO.070107B	PATA DECORATIVA CROMO BRILLO LUXE DE 15 40*40 C/REGULACIÓN	



## PATAS MESAS

CÓDIGO	DESCRIPCIÓN	
CO.07020101	PATA MESA 71CM BLANCO	
CO.07020103	PATA MESA 71CM NEGRO	
CO.07020102	PATA MESA 71CM CROMO	
CO.07020106	PATA MESA 71CM INOX	
CO.07020201	PATA MESA 81CM BLANCO	
CO.07020203	PATA MESA 81CM NEGRO	
CO.07020202	PATA MESA 81CM CROMO	EMB. 4 UDS.
CO.07020206	PATA MESA 81CM INOX	
CO.07020206A	PATA MESA 87 CM INOX	
CO.07020206AC	PATA MESA 87 CM CROMO MATE	
CO.07020203A	PATA MESA 87 CM NEGRA	
CO.07020201A	PATA MESA 87 CM BLANCA	
CO.07020202-A	PATA MESA 110 CM CROMO MATE DIAM. 80	
CO.07020202X	PATA MESA 110 CM NIQUEL SATINADO DIAM. 80	
CO.07020202AB	PATA MESA 110 CM CROMO BRILLO. DIAM. 80	EMB. 1 UDS.



## 07. PATAS, COLGADORES, SOPORTES, TOPES

### PATAS CUADRADAS

EMB. 4 UDS.

CÓDIGO	DESCRIPCIÓN
CO.07020206ACC	PATA CUADRADA INOX ALT. 87
E.3245662	PATA CUADRADA 710 MM
E.3245762	PATA CUADRADA 738 MM
E.3245862	PATA CUADRADA 830 MM



CÓDIGO	DESCRIPCIÓN
E.3068925	PATA CONUS 60*687/800

EMB. 1 UD.

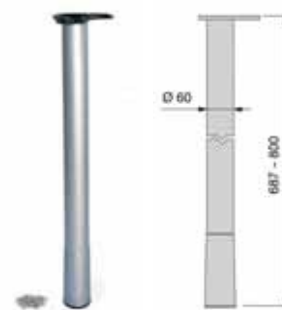

CÓDIGO	DESCRIPCIÓN
E.3061625	PATA CON RUEDA Y FRENO 60*735

EMB. 1 UD.



PATAS MESAS

CÓDIGO	DESCRIPCIÓN	EMB. 1 UDS.
D.0603087	PATA PLEGABLE ALUMINIO D50 H-705	



CÓDIGO	DESCRIPCIÓN	EMB. 1 UDS.
CO.07020202C	PATA EXTENSIBLE 700-1100 MM DE DIAM 50-60 MM ALUMINIO	
CO.07020202BL	PATA EXTENSIBLE 700-1100 MM DE DIAM 50-60 MM BLANCA	
CO.07020202N	PATA EXTENSIBLE 700-1100 MM DE DIAM 50-60 MM NEGRA	
CO.07020202B	PATA EXTENSIBLE 700-1100 MM DE DIAM 50-60 MM BRILLO	



COLGADORES Y ESCUADRAS

COLGADOR ANTIVUELCO ACUARIO 807

CÓDIGO	DESCRIPCIÓN
CO.070308A	COLGADOR MURAL ACUARIO 807 ANTIVUELCO DERECHA
CO.070308B	COLGADOR MURAL ACUARIO 807 ANTIVUELCO IZQUIERDA
CO.070309A	TAPA COLGADOR ACUARIO 807 BLANCA DERECHA
CO.070309B	TAPA COLGADOR ACUARIO 807 BLANCA IZQUIERDA
CO.070310	CHAPA COLGADOR ACUARIO 807 ANTIVUELCO



COLGADOR OCULTO REGULABLE BIVALENTE

CÓDIGO	DESCRIPCIÓN
CO.070301	JUEGO COLGADOR OCULTO REGULABLE BIVALENTE



ESCUADRA ABATIBLE

CÓDIGO	DESCRIPCIÓN
CO.07030830	ESCUADRA ABATIBLE DE 30*30
CO.07030840	ESCUADRA ABATIBLE DE 40*40



ESCUADRA ÁNGULO

CÓDIGO	DESCRIPCIÓN
CO.07030920	ESCUADRA ÁNGULO DE 20*20 pack de 100 unid
CO.07030930	ESCUADRA ÁNGULO DE 30*30pack de 100 unid.
CO.07030940	ESCUADRA ÁNGULOVA DE 40*40 pack de 100 unid



## 07. PATAS, COLGADORES, SOPORTES, TOPES,

### RUEDAS

#### SLIP

CÓDIGO	DESCRIPCIÓN	H	C*B	D*E	E	CARGA
E.2002121	RUEDA SLIP2 D50 PLET GR SIN FRENO	64	42*42	32*32	4,5	35 kg.
E.2002321	RUEDA SLIP2 D75 PLET GR SIN FRENO	96	60*60	45*45	6,5*8,5	40 kg.
E.2002221	RUEDA SLIP2 D50 PLET GR CON FRENO	64	42*42	32*32	4,5	35 kg.
E.2002421	RUEDA SLIP2 D75 PLET GR CON FRENO	96	60*60	45*45	6,5*8,5	40 kg.



#### SLIP2

EMB. 125 UDS.

CÓDIGO	DESCRIPCIÓN
E.2002521	RUEDA SLIP2 D50 M8*15 GR SIN FRENO
E.2002621	RUEDA SLIP2 D50 M8*15 GR CON FRENO



#### PLET

CÓDIGO	DESCRIPCIÓN
E.3036417	RUEDA D30 PLET NE S/F
E.3036617	RUEDA D40 PLET NE S/F
E.3036717	RUEDA D45 PLET NE S/F
E.3036817	RUEDA D50 PLET NE S/F
E.3037217	RUEDA D40 PLET NE C/F
E.3037417	RUEDA D50 PLET NE C/F



#### GIRATORIA

EMB. 1000 UDS.

CÓDIGO	DESCRIPCIÓN
E.3026105	RUEDA PARA TAPA GIRATORIA NEGRA



#### EXCÉNTRICAS Y TORNILLOS

EMB. 100 UDS.

CÓDIGO	DESCRIPCIÓN
CO.111402	SOPORTE EXCÉNTRICA HETTICH 19 (PACK DE 100 UNID.)
CO111402A	TORNILLO PARA SOPORTE EXCÉNTRICA HETTICH (PACK DE 100 UNID.)
H.65517	SOPORTE EXCENTRICA HETTICH 16 (PACK DE 100 UNID.)
H.64872	TORNILLO CORTO EXCENTRICA
H.65536	TORNILLO DOBLE EXCENTRICA 19 PACK (100 UDS)



CÓDIGO	DESCRIPCIÓN
IN.913209065	CASQUILLO CLOCK-3 9MM NIQUEL
IN.913409066	CASQUILLO CLOCK-5 9MM NIQUEL PLASTICO
IN.913009016	CASQUILLO CLOCK-2 9MM NIQUEL MARRON
IN.923311034	ENGANCHE TORNILLO R/M 3*1
IN.923510033	ENGANCHE TORNILLO R7M 10



# SOPORTES Y TOPES



CÓDIGO	DESCRIPCIÓN	EMB. 2500 UDS.
D.0733920	SOPORTE BALDA MADERA MOD. ÚNICO	



CÓDIGO	DESCRIPCIÓN	EMB. 500 UDS.
H.282.24.333	SOPORTE APOYO PLÁSTICO	



CÓDIGO	DESCRIPCIÓN	EMB. 500 UDS.
H.282.24.817	SOPORTE ANTRACITA antivuelco 9,4 KG.	
H.282.24.827	SOPORTE ANTRACITA antivuelco 15,6 KG.	



CÓDIGO	DESCRIPCIÓN	EMB. 100 UDS.
D.0600100	SOPORTE BALDA MOD. HUG	



Soporte Balda Hug

CÓDIGO	DESCRIPCIÓN	EMB. 100 UDS.
CO.070407	SOPORTE BALDA LEJAS TRANSPARENTE	



CÓDIGO	DESCRIPCIÓN	EMB. 100 UDS.
CO.070408	SOPORTE BALDA CRISTAL CON GOMA	



CÓDIGO	DESCRIPCIÓN	EMB. 100 UDS.
CO.070407A	SOPORTE SAFETY PACK TRANSPARENTE	



CÓDIGO	DESCRIPCIÓN	EMB. 100 UDS.
CO.07A138	SOPORTE ESCUADRA METÁLICO	



CÓDIGO	DESCRIPCIÓN	EMB. 100 UDS.
CO.070409	SOPORTE BALDA CILÍNDRICO CON ARANDELA	



CÓDIGO	DESCRIPCIÓN	EMB. 100 UDS.
CO.070412	TOPE PUERTA BIMATERIAL	



## 07. PATAS, COLGADORES, SOPORTES, TOPES,

### SOPORTES Y TOPES

CÓDIGO	DESCRIPCIÓN	EMB. 100 UDS.
CO.070408A	SOPORTE BALDA CRISTAL CON VENTOSA	
CO.070408B	SOPORTE ESTANTE CON VENTOSA	



CÓDIGO	DESCRIPCIÓN	EMB. 200 UDS.
CO.070414	SOPORTE CRISTAL REGULABLE 4-6MM NÍQUEL	
CO.070414A	SOPORTE CRISTAL RECTANGULAR REGULABLE 4-6MM CROMO	EMB. 50 UDS.



CÓDIGO	DESCRIPCIÓN	EMB. 100 UDS.
CO.070309MA-1	ESCUADRA ENSAMBLE DOBLE 100*10 CON TAPA MARRÓN	
CO.070309BL-1	ESCUADRA ENSAMBLE DOBLE 100*10 CON TAPA BLANCO	
CO.070309G-1	ESCUADRA ENSAMBLE DOBLE 100*10 CON TAPA GRIS	



CÓDIGO	DESCRIPCIÓN	EMB. 100 UDS.
CO.07040601	TOPES PUERTA TIRA BLANCO	
CO.07040604	TOPES PUERTA TIRA MARRÓN	
CO.07040605	TOPES PUERTA TIRA GRIS	



CÓDIGO	DESCRIPCIÓN	EMB. 100 UDS.
CO.07040501	TOPES PUERTA TRASERO BLANCO	
CO.07040504	TOPES PUERTA TRASERO MARRÓN	



CÓDIGO	DESCRIPCIÓN	EMB. 100 UDS.
CO.070403A01	TOPES GUITARRA PEQUEÑO BLANCO	
CO.070403A04	TOPES GUITARRA PEQUEÑO MARRÓN	
CO.070403B01	TOPES GUITARRA GRANDE BLANCO	
CO.070403B04	TOPES GUITARRA GRANDE MARRÓN	



CÓDIGO	DESCRIPCIÓN	EMB. 100 UDS.
CO.07040401	TOPES DOS PUNTAS BLANCO	
CO.07040404	TOPES DOS PUNTAS MARRÓN	



### NIVELADORES

CÓDIGO	DESCRIPCIÓN	EMB. 100 UDS.
CO.070413A	NIVELADOR BLANCO 0-15 MM	
CO.070413	NIVELADOR NEGRO 0-15 MM	



CÓDIGO	DESCRIPCIÓN	EMB. 250 UDS.
CO.070415	NIVELADOR NEGRO 44-65 DIAM. 49	
CO.070415A	NIVELADOR NEGRO 27-48 DIAM. 49	





SOPORTES Y TOPES

SOPORTE BALDAS DECORATIVOS

CÓDIGO	DESCRIPCIÓN	EMB. 1 JUEGO
CO.070401106	JUEGO SOPORTE PELICANO GRANDE CROMO MATE 70*105 REGULACION 4-40 MM.	EMB. 1 JUEGO
CO.070401706	JUEGO SOPORTE PELICANO MEDIANO CROMO MATE 60*75 REGULACION 4-26 MM.	EMB. 2 JUEGOS
	DISPONIBLES EN CROMO, CROMO MATE, NÍQUEL-MATE, BLANCO, NEGRO Y ORO VIEJO	



CÓDIGO	DESCRIPCIÓN	EMB. 1 JUEGO
CO.070401	JUEGO KALABRONE 8 A 30 MM. CROMO MATE	EMB. 1 JUEGO
	Carga máxima por soporte 25 Kg. en balda de 320 mm. máximo de fondo. Espesor de tablero de 8 mm. a 30 mm. Dispone de regulación para la inclinación del tablero	



CÓDIGO	DESCRIPCIÓN	EMB. 1 JUEGO
CO.070402	JUEGO KAIMAN 125 MM. CROMO MATE	EMB. 1 JUEGO
	REGULACIONES DE 7 A 19 MM, DE 18 A 30 MM Y DE 29 A 41 MM.	



CÓDIGO	DESCRIPCIÓN	EMB. 2 JUEGOS
CO.070403	JUEGO ESTANTE REGULABLE 80*80 MM. NÍQUEL MATE 4-50 MM.	EMB. 2 JUEGOS
	DISPONIBLES EN COLORES CROMO, CROMO MATE, NÍQUEL MATE, BLANCO MATE Y NEGRO MATE	



CÓDIGO	DESCRIPCIÓN	EMB. 50 UDS.
CO.070404	PORTA ESTANTE CON PLACA FIJO M-10*110 MM CINCADO	EMB. 50 UDS.



CÓDIGO	DESCRIPCIÓN	EMB. 1000 UDS.
CO.070410	TOPES LÁGRIMA ADHESIVOS pack de 1000 unid.	EMB. 1000 UDS.



## 07. PATAS, COLGADORES, SOPORTES, TOPES,

### SOPORTES Y TOPES. TAPA TORNILLOS



# SISTEMAS DE RECICLAJE



  
COALFE



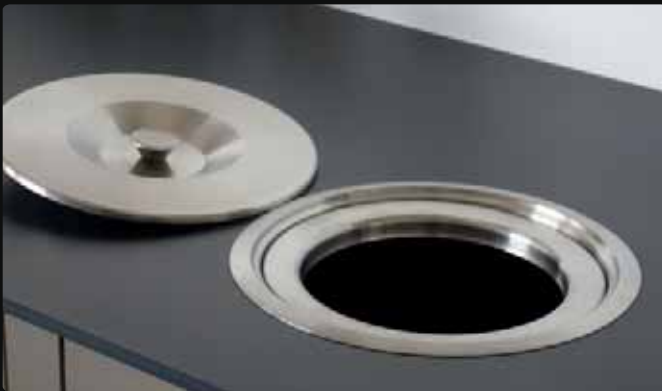

## 08. CUBOS Y SALIDAS DE HUMOS

### SISTEMAS DE RECICLAJE

#### CUBO REDONDO

CÓDIGO	DESCRIPCIÓN	ALTO	Ø	LITROS	ACABADO
CO.080101	CUBO BASURA REDONDO BLANCO	350	280	14	BLANCO
CO.080102	CUBO BASURA REDONDO INOX	350	280	14	INOX



#### CUBO EXTRAÍBLE

CÓDIGO	DESCRIPCIÓN	MUEBLE	ANCHO	FONDO	ALTO	LITROS	ACABADO
CO.08010435	CUBO ECOLÓGICO RECTANGULAR 1 CUBETA MOD. 35	350	280	370	350	17	ANTRACITA
CO.08010440	CUBO ECOLÓGICO RECTANGULAR 2 CUBETAS MOD. 40	400	360	475	355	17+17	ANTRACITA
CO.08010440B	CUBO ECOLÓGICO RECTANGULAR 3 CUBETAS MOD. 40	400	360	475	355	17+8,5+8,5	ANTRACITA



## 08. CUBOS Y SALIDAS DE HUMOS

### SISTEMAS DE RECICLAJE

#### METRÓPOLIS

CÓDIGO	DESCRIPCIÓN
D.0417520	KIT DE RECICLAJE METRÓPOLIS MOD. 60 H28 ANTRACITA 15+15 L.
D.0417820	KIT DE RECICLAJE METRÓPOLIS MOD. 60 H23 ANTRACITA 12+12 L.



CÓDIGO	DESCRIPCIÓN
D.0417620	KIT DE RECICLAJE METRÓPOLIS MOD. 80 H28 ANTRACITA 15+15+15 L.
D.0417920	KIT RECICLAJE METRÓPOLIS MOD. 80 H.23 CM ANTRACITA 12+12+12L.



CÓDIGO	DESCRIPCIÓN
D.0417720	KIT DE RECICLAJE METRÓPOLIS MOD. 90 H28 ANTRACITA 15+15+15 L.
D.0418020	KIT RECICLAJE METRÓPOLIS MOD. 90 H23 ANTRACITA 12+12 + 12 L.



CÓDIGO	DESCRIPCIÓN
D.0310707	KIT DE RECICLAJE METRÓPOLIS MOD. 120 H28 ANTRA 15+15+15+15L.
D.0310807	KIT DE RECICLAJE METRÓPOLIS MOD. 120 H23 ANTRA 15+15+15+15L.



#### SQUARE

CÓDIGO	DESCRIPCIÓN
D.0417120	SET CUBOS SQUARE 2.0 MOD. 45 ( 24 L. + 24 L.)
D.0417220	SET CUBOS SQUARE 2.0 MOD. 60 ( 24 +12+12+8 L.)



#### ECOFIL

CÓDIGO	DESCRIPCIÓN	MUEBLE	ANCHO	FONDO	ALTO	LITROS	ACABADO
D.0401507	CUBOS EXTRAÍBLE ECOFIL GRIS 24+24 L.	400	300	450	460	24+24	ANTRACITA
	Estos cubos se fijan a la base del mueble, siendo el requerimiento mínimo de ancho del mismo 400 mm.						



## 08. CUBOS Y SALIDAS DE HUMOS

### SISTEMAS DE RECICLAJE

#### MAXITECNOKIT

CÓDIGO	DESCRIPCIÓN	MUEBLE	ANCHO	FONDO	ALTO	LITROS	ACABADO
D.0451789	CUBO MAXITECNOKIT MOD. 60 8+25 L.	600	513	473	270	25+8	GRIS/INOX
D.0451889	COBO MAXITECNOKIT MOD. 80 25+25 L.	800	713	473	270	25+25	GRIS/INOX
D.0451989	CUBO MAXITECNOKIT MOD. 90 25+8+25 L.	900	813	473	270	25+8+25	GRIS/INOX
D.0452089	CUBO MAXITECNOKIT MOD. 120 25+8+8+25 L.	1200	1113	473	270	25+8+8+25	GRIS/INOX

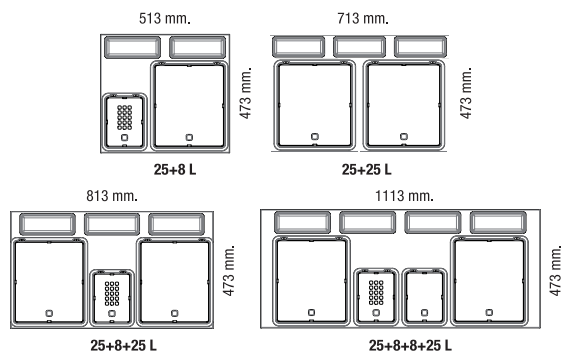

#### CUBO ENCASTRABLE

CÓDIGO	DESCRIPCIÓN	ALTO	Ø ENCASTRE	Ø TOTAL	LITROS	ACABADO
CO.080107	CUBO BASURA ENCASTRABLE EN ENCIMERA	250	240	270	8	INOX

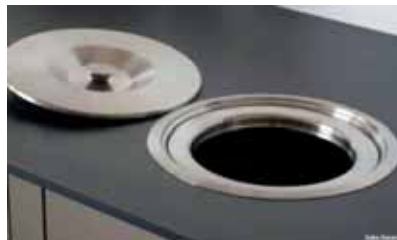
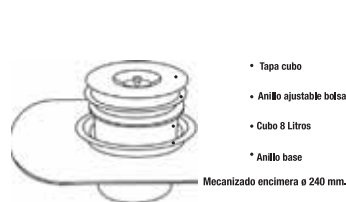

#### SALVA SIFÓN CURVO

EMB. 10 UDS.

CÓDIGO	DESCRIPCIÓN
E.3012121	SALVA SIFÓN 258*120*82 GR. DISPONIBLE EN GRIS, ANTRACITA Y BLANCO



#### SALVA SIFÓN RECTANGULAR

EMB. 6 UDS.

CÓDIGO	DESCRIPCIÓN
E.3011421	SALVA SIFON RECTANGULAR 322*186*83 DISPONIBLE EN GRIS, ANTRACITA Y BLANCO



#### PERFIL SALVA SIFÓN

CÓDIGO	DESCRIPCIÓN	EMB.
D.0315520	PERFIL SALVA SIFÓN LIBERO 2MT GRIS	EMB. 10 UDS.
D.0315620	SET ÁNGULOS PERFIL SALVA SIFÓN LIBERO	EMB. 25 UDS.
	DISPONIBLE EN GRIS ANTRACITA Y BLANCO	



## 08. CUBOS Y SALIDAS DE HUMOS

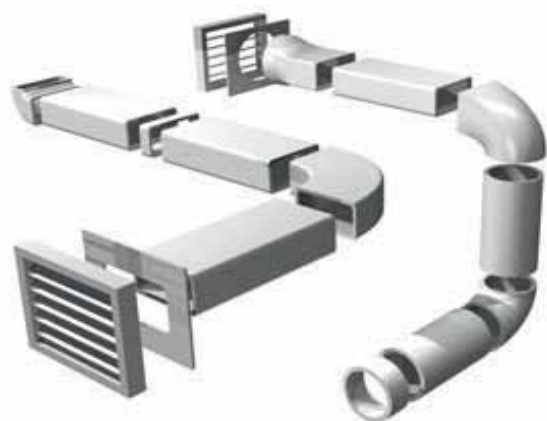

# SALIDAS DE HUMO

### ACCESORIOS

#### SERIE 600 Ø 100 MM

CÓDIGO	DESCRIPCIÓN	EMBALAJE
CO.08020605	TUBO REDONDO DE 100*150MM	8 UDS
CO.08020601	TUBO RECTANGULAR DE 60*120*150MM	9 UDS
CO.08020615	EMPALME REDONDO DE 100*41M	40 UDS
CO.08020610	EMPALME RECTANGULAR DE 60*120MM	56 UDS
CO.08020620	EMPALME MIXTO DE 100 A 60*120MM	48 UDS
CO.08020625	CODO MIXTO DE 100 A 60*120MM	38 UDS
CO.08020630	CODO RECTANGULAR VERTICAL DE 90° 60*120MM	52 UDS
CO.08020635	CODO RECTANGULAR HORIZONTAL 90° DE 60*120MM	45 UDS
CO.08020640	EMBELLECEDOR PARED RECTANGULAR 60*120MM	25 UDS
CO.08020645	REMATE PARED REDONDO TUBO 100	25 UDS
CO.08020652	VENTANILLA SALIDA EXT. RECTANGULAR	30 UDS
CO.08020653	VENTANILLA SALIDA EXT. REDONDA	20 UDS
CO.08020660	ARO REDUCTOR SALIDA 125 A 100MM	40 UDS
CO.08020670	CODO REDONDO-REDONDO 90° 100MM	36 UDS

#### SERIE 800 Ø 120 MM

CÓDIGO	DESCRIPCIÓN	EMBALAJE
CO.08020805	TUBO REDONDO 120*150MM SERIE 800	8 UDS
CO.08020801	TUBO RECTANGULAR 145*150MM SERIE 800	9 UDS
CO.08020826	CODO MIXTO 120 A 60*145MM SERIE 800	24 UDS
CO.08020852	VENTANILLA REDONDA 120 MM	20 UDS
CO.08020830	CODO RECTANGULAR-VERTICAL 90° DE 60*145MM	38 UDS
CO.08020870	CODO REDONDO-REDONDO 90° 120MM	22 UDS
CO.08020815	EMPALME REDONDO DE 120MM	24 UDS
CO.08020810	EMPALME RECTANGULAR DE 60*145MM	27 UDS
CO.08020820	EMPALME MIXTO DE 120 A 60*145MM	28 UDS
CO.08020835	CODO RECTANGULAR - HORIZONTAL 90° DE 60*145MM	24 UDS
CO.0802840	REMATE PARED RECTANGULAR 150*75 MM	25 UDS
CO.0802845	REMATE PARED REDONDO 120 MM	25 UDS
CO.0802850	VENTANILLA SALIDA RECTANGULAR 150*75 MM	25 UDS

#### SERIE 800 A Ø 150 MM

CÓDIGO	DESCRIPCIÓN	EMBALAJE
CO.08020805A	TUBO REDONDO DE 150*150MM SERIE 800	9 UDS
CO.08020815A	EMPALME REDONDO DE 150*41MM	16 UDS
CO.08020870A	CODO REDONDO 90° 150MM	11 UDS
CO.08020660A	ARO REDUCTOR SALIDA 150 A 125MM	40 UDS



## 09. CESTILLERÍA

### CESTILLERÍA GAMA ECO

CÓDIGO	DESCRIPCIÓN	EMB. 1 UD.
CO.09010415	CESTO BOTELLERO MOD. 15 CON FRENO	
CO.09010420	CESTO BOTELLERO MOD. 20 CON FRENO	

ALTURA 80

CÓDIGO	DESCRIPCIÓN	EMB. 1 UD.
CO.09010415A	CESTO BOTELLERO CON FRENO MOD. 15 ALT. 80	
CO.09010420A	CESTO BOTELLERO CON FRENO MOD. 20 ALT. 80	
CO.09010425A	CESTO BOTELLERO CON FRENO MOD. 25 ALT. 80	

30 kg.

FRENO



CÓDIGO	DESCRIPCIÓN	EMB. 1 UD.
CO.09010130	CESTO BOTELLERO PANERO MOD. 30 CON FRENO	
CO.09010140	CESTO BOTELLERO PANERO MOD. 40 CON FRENO	

30 kg.

FRENO



CÓDIGO	DESCRIPCIÓN	EMB. 1 UD.
CO.09010230	CESTO VERDULERO –BOTELLERO MOD. 30 CON FRENO	
CO.09010240	CESTO VERDULERO—BOTELLERO MOD. 40 CON FRENO	

30 kg.

FRENO



CÓDIGO	DESCRIPCIÓN	EMB. 1 UD.
CO.09010230A	CESTO VERDULERO EXTR. CON FRENO MOD. 30. ALT. . 80	
CO.09010240A	CESTO VERDULERO EXTR. CON FRENO MOD. 40. ALT. . 80	

CÓDIGO	DESCRIPCIÓN	EMB. 4 UDS.
CO.09010730	CESTO MULTIUSO MOD. 30 CON FRENO	
CO.09010735	CESTO MULTIUSO MOD. 35 CON FRENO	
CO.09010740	CESTO MULTIUSO MOD. 40 CON FRENO	
CO.09010745	CESTO MULTIUSO MOD. 45 CON FRENO	
CO.09010750	CESTO MULTIUSO MOD. 50 CON FRENO	
CO.09010760	CESTO MULTIUSO MOD. 60 CON FRENO	

30 kg.

FRENO



## 09. CESTILLERÍA

### CESTILLERÍA MUEBLE RINCÓN

#### COMPACT HYPER

EMB. 1 UD.

CÓDIGO	DESCRIPCIÓN
D.0500102	BASTIDOR ÁNGULO BAJO FRENO MOD. COMPACT HYPER ANTRACITA SUELO COMPACTO MOD. 40 (ANCHOPUERTA400*ANCHOMÓDULO700*ALT560*FONDO480)
D.0500202	BASTIDOR ÁNGULO BAJO FRENO MOD. COMPACT HYPER ANTRACITA SUELO COMPACTO MOD. 45 (ANCHOPUERTA450*ANCHOMÓDULO700*ALT560*FONDO480)
D.0500302	BASTIDOR ÁNGULO BAJO FRENO MOD. COMPACT HYPER ANTRACITA SUELO COMPACTO MOD. 50 (ANCHOPUERTA500*ANCHOMÓDULO740*ALT560*FONDO480)
D.0500402	BASTIDOR ÁNGULO BAJO FRENO MOD. COMPACT HYPER ANTRACITA SUELO COMPACTO MOD. 60 (ANCHOPUERTA600*ANCHOMÓDULO940*ALT560*FONDO480)



#### HIDDEN CORNER BANDEJA ANTIDESLIZANTE

EMB. 1 UD.

CÓDIGO	DESCRIPCIÓN
CO.09020445FA	BASTIDOR ÁNGULO BAJO F. 45 FRENO BANDEJA ANTIDESLIZANTE DISPONIBLE EN BLANCO Y ANTRACITA



#### HIDDEN CORNER

EMB. 1 UD.

CÓDIGO	DESCRIPCIÓN
CO.09020440F	BASTIDOR ÁNGULO BAJO MOD. 40-45 FRENO



#### CESTO RIÑÓN

EMB. 1 UD.

CÓDIGO	DESCRIPCIÓN
CO.09020645D	BANDEJA RIÑON PUERTA 45 DERECHA
CO.09020645I	BANDEJA RIÑON PUERTA 45 IZQUIERDA



#### ROTATORIO

EMB. 1 UD.

CÓDIGO	DESCRIPCIÓN
CO.090203	BASTIDOR ÁNGULO BAJO ROTATORIO 270° BARRA



#### BANDEJA 270°

EMB. 1 UD.

CÓDIGO	DESCRIPCIÓN
CO.09020230	BANDEJA GIRATORIA 270° BARRA PUERTA 30
CO.09020240	BANDEJA GIRATORIA 270° BARRA PUERTA 40



## 09. CESTILLERÍA

### CESTILLERÍA MUEBLE RINCÓN

#### COOKING AGENT

EMB. 1 UD.

CÓDIGO	DESCRIPCIÓN
D.0450191	COOKING AGENT ANCHO 300 ALTO 625



#### CLEANING AGENT

EMB. 1 UD.

CÓDIGO	DESCRIPCIÓN
D.0426320	CLEANING AGENT ANCHO 298 ALTO 480



#### DISPENSA JUNIOR III

EMB. 1 UD.

CÓDIGO	DESCRIPCIÓN
D.0414320	BASTIDOR DISPENSA JUNIOR MOD 300
D.0414420	BASTIDOR DISPENSA JUNIOR MOD 400
D.0414620	BASTIDOR DISPENSA JUNIOR MOD 500
D.0414720	BASTIDOR DISPENSA JUNIOR MOD 600



CÓDIGO	DESCRIPCIÓN
D.0450191	BANDEJA VARILLA CROMO DISPENSA JUNIOR 300
D.0450291	BANDEJA VARILLA CROMO DISPENSA JUNIOR 400

EMB. 1 UD.



Varilla Cromo

CÓDIGO	DESCRIPCIÓN
D.0421720	SET JUEGO 2 BANDEJAS CLASSIC DISPENSA JUNIOR MOD.300
D.0421820	SET JUEGO 2 BANDEJAS CLASSIC DISPENSA JUNIOR MOD.400
D.0421920	SET JUEGO 2 BANDEJAS CLASSIC DISPENSA JUNIOR MOD.500
D.0422020	SET JUEGO 2 BANDEJAS CLASSIC DISPENSA JUNIOR MOD.600

EMB. 1 UD.



Bandeja Classic Cromo Gris

CÓDIGO	DESCRIPCIÓN
D.0421001	SET JUEGO 2 BANDEJAS STYLE DISPENSA JUNIOR MOD.300
D.0421101	SET JUEGO 2 BANDEJAS STYLE DISPENSA JUNIOR MOD.400

EMB. 1 UD.



Bandeja Style Cromo Blanco

CÓDIGO	DESCRIPCIÓN
D.0431601	SET 2 YOUBOXX DISPENSA JUNIOR
D.0431701	SET 3 YOUBOXX DISPENSA JUNIOR
D.0431801	SET 5 YOUBOXX DISPENSA JUNIOR

EMB. 1 UD.



Set 2 YouBoxx

Set 3 YouBoxx

Set 5 YouBoxx

## 09. CESTILLERÍA

### CESTILLERÍA GAMA OTTOCENTO



CESTILLERÍA CON EXTRACCIÓN TOTAL CON FRENO ALTURA 80

#### CESTO BOTELLERO OTTOCENTO

CÓDIGO	DESCRIPCIÓN	EMB. 1 UD.
CO.09040415A8	CESTO BOTELLERO EXT. TOTAL CON FRENO MOD. 15 ANTRACITA ALT. 80 OTTOCENTO	
CO.09040420A8	CESTO BOTELLERO EXT. TOTAL CON FRENO MOD. 20 ANTRACITA ALT. 80 OTTOCENTO	
CO.09040425A8	CESTO BOTELLERO EXT. TOTAL CON FRENO MOD. 25 ANTRACITA ALT. 80 OTTOCENTO	



#### CESTO BOTELLERO - PANERO OTTOCENTO

CÓDIGO	DESCRIPCIÓN	EMB. 1 UD.
CO.09040130A8	CESTO BOTELLERO- PANERO EXT. TOTAL CON FRENO MOD. 30 ANTRACITA ALT. 80 OTTOCENTO	
CO.09040140A8	CESTO BOTELLERO PANERO EXT. TOTAL CON FRENO MOD. 40 ANTRACITA ALT. 80 OTTOCENTO	



#### CESTO VERDULERO OTTOCENTO

CÓDIGO	DESCRIPCIÓN	EMB. 1 UD.
CO.09040330A8	CESTO VERDULERO 3 CESTOS EXT. TOTAL CON FRENO MOD. 30 ANTRACITA ALT. 80 OTTOCENTO	
CO.09040340A8	CESTO VERDULERO 3 CESTOS EXT. TOTAL CON FRENO MOD. 40 ANTRACITA ALT. 80 OTTOCENTO	



#### KIT BASES OTTOCENTO

CÓDIGO	DESCRIPCIÓN	EMB. 1 UD.
CO.0904-BB15	KIT BASES COMPACTO BOTELLERO ANTRACITA MOD. 15 OTTOCENTO	
CO.0904-BB20	KIT BASES COMPACTO BOTELLERO ANTRACITA MOD. 20 OTTOCENTO	
CO.0904-BB25	KIT BASES COMPACTO BOTELLERO ANTRACITA MOD. 25 OTTOCENTO	
CO.0904-BB30	KIT BASES COMPACTO BOTELLERO ANTRACITA MOD. 30 OTTOCENTO	
CO.0904-BB40	KIT BASES COMPACTO BOTELLERO ANTRACITA MOD. 40 OTTOCENTO	
CO.904-B330	KIT BASE COMPACTO 3 CESTAS MOD. 30 OTTOCENTO	
CO.904-B340	KIT BASE COMPACTO 3 CESTAS MOD. 40 OTTOCENTO	

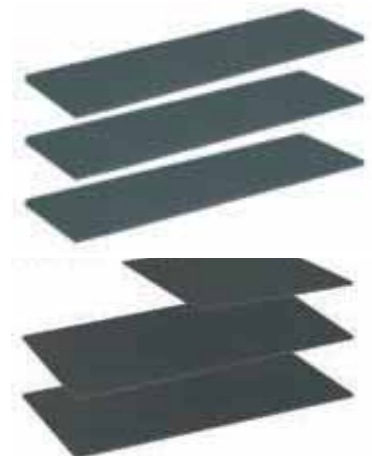





09. CESTILLERÍA



CESTILLERÍA GAMA GREEN LINE



CESTO BOTELLERO

CÓDIGO	DESCRIPCIÓN	EMB. 1 UD.
CO.002G00312	CESTO BOTELLERO MOD.15 GREEN LINE	
CO.002G00712	CESTO BOTELLERO MOD.20 GREEN LINE	
CO.002G01012	CESTO BOTELLERO MOD.15 F.28 GREEN LINE	
CO.003G01212	CESTO BOTELLERO MOD.25 GREEN LINE	



CESTO VERDULERO

CÓDIGO	DESCRIPCIÓN	EMB. 1 UD.
CO.003G00112	CESTO VERDULERO BOTELLERO MOD. 30 GREEN LINE	
CO.003G00512	CESTO VERDULERO BOTELLERO MOD. 40 GREEN LINE	
CO.003G00212	CESTO VERDULERO BOTELLERO MOD. 45 GREEN LINE	



CESTO PANERO

CÓDIGO	DESCRIPCIÓN	EMB. 1 UD.
CO.006G00212	CESTO BOTELLERO PANERO MOD. 30 GREEN LINE	
CO.006G00312	CESTO BOTELLERO PANERO MOD. 40 GREEN LINE	



CESTO LIMPIEZA

CÓDIGO	DESCRIPCIÓN	EMB. 1 UD.
CO.060G00412	CESTO LIMPIEZA REVERSIBLE MOD. 30 GREEN LINE	



CÓDIGO	DESCRIPCIÓN	EMB. X UD.
CO.999G00312	CESTO ESCURREPLATO BAJO CON FRENO GREEN LINE MOD. 60 564*500*110	



## 09. CESTILLERÍA

### CESTILLERÍA GAMA INFINITY PLUS



#### CESTO BOTELLERO

EMB. 1 UD.

CÓDIGO	DESCRIPCIÓN
CO.002+00412S	CESTO BOTELLERO PLANO MOD.15 INFINITY PLUS
CO.002+01012S	CESTO BOTELLERO PLANO MOD.20 INFINITY PLUS



#### CESTO VERDULERO

EMB. 1 UD.

CÓDIGO	DESCRIPCIÓN
CO.004+02012S	CESTO VERDULERO PLANO MOD. 30 INFINITY PLUS
CO.004+02312S	CESTO VERDULERO PLANO MOD. 40 INFINITY PLUS



#### CESTO PANERO

EMB. 1 UD.

CÓDIGO	DESCRIPCIÓN
CO.006+00412S	CESTO BOTELLERO PANERO PLANO MOD. 30 INFINITY PLUS
CO.006+00512S	CESTO BOTELLERO PANERO PLANO MOD. 40 INFINITY PLUS



#### KIT SEPARADORES

EMB. 1 UD.

CÓDIGO	DESCRIPCIÓN
CO.066+00100	KIT SEPARADOR BOTELLAS PARA 300-450-600PLANO INFINITY



#### SEPARADORES

EMB. 1 UD.

CÓDIGO	DESCRIPCIÓN
CO.065+00002	KIT SEPARADOR BOTELLAS PARA 150 PLANO INFINITY PLUS





## 09. CESTILLERÍA

### CESTILLERÍA GAMA INFINITY PLUS



#### BANDEJA GIRATORIA

EMB. 1 UD.

CÓDIGO	DESCRIPCIÓN
CO363+00212	BANDEJA GIRATORIA PLANA ESTANTE 270° MOD. D.70 INFINITY PLUS
CO.363+00312	BANDEJA GIRATORIA PLANA ESTANTE 270° MOD. D.80 INFINITY PLUS
CO.363+00612	CESTO ADAPTADOR DEL 363+ PARA 45° INFINITY PLUS

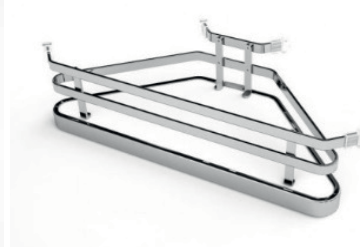
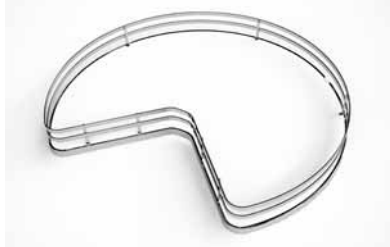

#### BANDEJA GIRATORIA CON BARRA

EMB. 1 UD.

CÓDIGO	DESCRIPCIÓN
CO.361+00112	BANDEJA 270° GIRATORIA INFINITY PLUS CON BARRA D. 80



#### BANDEJA NÚVOLA

EMB. 1 UD.

CÓDIGO	DESCRIPCIÓN
CO.371+004S12	BANDEJA NÚVOLA PLANA BASE MELAMNINA BL. P.45 INFINITY PLUS IZQUIERDO
CO.371+004D12	BANDEJA NÚVOLA PLANA BASE MELAMNINA BL. P.45 INFINITY PLUS DERECHO
CO.371+007D12	BANDEJA NÚVOLA PLANA BASE MELAMNINA BL. P.40 INFINITY PLUS DERECHO
CO.371+007S12	BANDEJA NÚVOLA PLANA BASE MELAMNINA BL. P.40 INFINITY PLUS IZQUIERDO
CO.371+006D12	BANDEJA NÚVOLA PLANA BASE MELAMNINA BL. P.60 INFINITY PLUS DERECHO
CO.371+006S12	BANDEJA NÚVOLA PLANA BASE MELAMNINA BL. P.60 INFINITY PLUS IZQUIERDO



#### ACCESORIOS BANDEJA NÚVOLA

CÓDIGO	DESCRIPCIÓN	EMB. 1 UD.
CO.37100001	KIT FRENO SOFT CLOSING PARA NÚVOLA	



CÓDIGO	DESCRIPCIÓN	EMB. 1 UD.
CO.371K001D10	SOPORTE METAL NÚVOLA 371+ DERECHO	
CO.371K001S10	SOPORTE METAL NÚVOLA 371+ IZQUIERDO	





CÓDIGO	DESCRIPCIÓN
CO.258+00212	BASTIDOR COLUMNA EXTRAIBLE MOD. 15 CON 5 CESTOS INFINITY PLUS 1880/2180
CO.258+00312	BASTIDOR COLUMNA EXTRAIBLE MOD. 20 CON 5 CESTOS INFINITY PLUS 1880/2180



## 09. CESTILLERÍA

### CESTILLERÍA GAMA PROLINE

PRO.LINE



#### CESTO BOTELLERO

EMB. 1 UD.

CÓDIGO	DESCRIPCIÓN
CO.002PRO150027ST	002 PRO CESTO BOTELLERO 15 CON GUÍAS EXTRACCIÓN TOTAL (IZQUIERDA) CON AMORTIGUADOR DOS COBERTURAS INCLUIDAS 150*110*500*520 + 2 ESTERILLAS 002 PRO 15 + 4 DIVISIONES 002 PRO 15
CO.002PRO200027ST	002 PRO CESTO BOTELLERO 20 CON GUÍAS EXTRACCIÓN TOTAL (IZQUIERDA) CON AMORTIGUADOR DOS COBERTURAS INCLUIDAS 200*160*500*520 + 2 ESTERILLAS 002 PRO 20 + 4 DIVISIONES 002 PRO 20



#### CESTO VERDULERO

EMB. 1 UD.

CÓDIGO	DESCRIPCIÓN
CO.004PRO300027ST	004 PRO CESTO BOTELLERO 30 CON GUÍAS EXTRACCIÓN TOTAL (IZQUIERDA) CON AMORTIGUADOR DOS COBERTURAS INCLUIDAS 300*264*500*520 + 2 ESTERILLAS 004 PRO 30 + 4 DIVISIONES 004 PRO 30
CO.004PRO400027ST	004 PRO CESTO BOTELLERO 40 CON GUÍAS EXTRACCIÓN TOTAL (IZQUIERDA) CON AMORTIGUADOR DOS COBERTURAS INCLUIDAS 400*364*500*520 + 2 ESTERILLAS 004 PRO 40 + 4 DIVISIONES 004 PRO 40



#### CESTO PANERO

EMB. 1 UD.

CÓDIGO	DESCRIPCIÓN
CO.007PRO300027ST	007 PRO CESTO BOTELLERO PANERO 30 CON GUÍAS EXTRACCIÓN TOTAL (IZQUIERDA) CON AMORTIGUADOR 300*264*500*520 + 2 ESTERILLAS 007 PRO 30 + 4 DIVISIONES 007 PRO 30
CO.007PRO400027ST	007 PRO CESTO BOTELLERO PANERO 40 CON GUÍAS EXTRACCIÓN TOTAL (IZQUIERDA) CON AMORTIGUADOR 400*364*500*520 + 2 ESTERILLAS 007 PRO 40 + 4 DIVISIONES 007 PRO 40



## 09. CESTILLERÍA

### CESTILLERÍA GAMA PROLINE

PRO.LINE



#### CESTO INTERIOR

CÓDIGO	DESCRIPCIÓN
CO.119PRO600021ST	119 PRO CAJÓN CESTO 60 CON GUÍAS EXTRACCIÓN TOTAL Y AMORTIGUADOR FONDO EN LAMINA METÁLICA 600*560*500*100 + ESTERILLA 119 PRO 60



#### BANDEJA GIRATORIA

CÓDIGO	DESCRIPCIÓN
CO.363PRO700021T	363 PRO 2 TRAYS CARRUSEL GIRATORIO LÁMINA METÁLICA Y FONDO MELAMINA 2 ESTANTES 900*700*700*110 + 2 ESTERILLAS 363 PRO



#### BANDEJA NÚVOLA

CÓDIGO	DESCRIPCIÓN
CO.371P400021TD	371 PRO 2 SHELVES 40 DOS CESTOS EXTRAÍBLES EN LÁMINA METÁLICA Y FONDO MELAMINA PARA ESQUINA. CAPACIDAD PARA 25KG. MANO DERECHA 800*400*500*650 + 2 ESTERILLAS 371 PRO 2 45
CO.371P400021TS	371 PRO 2 SHELVES 40 DOS CESTOS EXTRAÍBLES EN LÁMINA METÁLICA Y FONDO MELAMINA PARA ESQUINA. CAPACIDAD PARA 25KG. MANO IZQUIERDA 800*400*500*650 + 2 ESTERILLAS 371 PRO 2 45
CO.371P450021TD	371 PRO 2 SHELVES 45 DOS CESTOS EXTRAÍBLES EN LÁMINA METÁLICA Y FONDO MELAMINA PARA ESQUINA. CAPACIDAD PARA 25KG. MANO DERECHA 900*450*500*650 + 2 ESTERILLAS 371 PRO 2 45
CO.371P450021TS	371 PRO 2 SHELVES 45 DOS CESTOS EXTRAÍBLES EN LÁMINA METÁLICA Y FONDO MELAMINA PARA ESQUINA. CAPACIDAD PARA 25KG. MANO IZQUIERDA 900*450*500*650 + 2 ESTERILLAS 371 PRO 2 45
CO.371P600021TD	371 PRO 2 SHELVES 60 DOS CESTOS EXTRAÍBLES EN LÁMINA METÁLICA Y FONDO MELAMINA PARA ESQUINA. CAPACIDAD PARA 25KG. MANO DERECHA 1000*600*500*650 + 2 ESTERILLAS 371 PRO 2 60
CO.371P600021TS	371 PRO 2 SHELVES 60 DOS CESTOS EXTRAÍBLES EN LÁMINA METÁLICA Y FONDO MELAMINA PARA ESQUINA. CAPACIDAD PARA 25KG. MANO IZQUIERDA 1000*600*500*650 + 2 ESTERILLAS 371 PRO 2 60





# ILUMINACIÓN Y CONECTIVIDAD

## TWIST

EMB. 1 UD.

CÓDIGO	DESCRIPCIÓN
D.0700690	TWIST 2 SCHUKO INOX ALTO 43*DIAM115* ENCASTRE105
D.0706401	TWIST 2 SCHUKO BLANCO MATE ALTO 43*DIAM115* ENCASTRE105
D.0701307	TWIST 2 SCHUKO NEGRO MATE ALTO 43*DIAM115* ENCASTRE105
D.0810490	TWIST 1 SCHUKO/2 USB INOX ALTO 43*DIAM115* ENCASTRE105
D.0811301	TWIST 1 SCHUKO/2 USB BLANCO MATE ALTO 43*DIAM115* ENCASTRE105
D.0810707	TWIST 1 SCHUKO/2 USB NEGRO MATE ALTO 43*DIAM115* ENCASTRE105

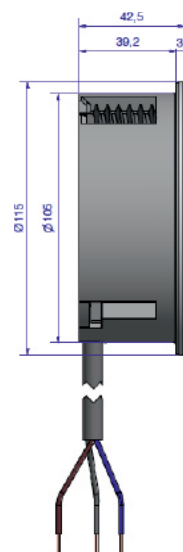

## PORT

EMB. 1 UD.

CÓDIGO	DESCRIPCIÓN
CO.1008	TORRE ESPÍA 3 SCHUKO



## URBAN

EMB. 1 UD.

CÓDIGO	DESCRIPCIÓN
CO.1013	TORRE ESPÍA 3 SCHUKO/2 USB
D.0712187	TORRE ESPÍA 3 SCHUKO

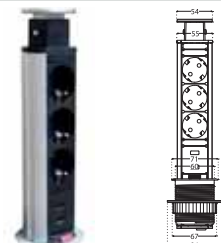

## ELEVATOR

EMB. 1 UD.

CÓDIGO	DESCRIPCIÓN
CO.1012	ENCASTRE ENCHUFE ELEVATOR 2 ACABADO INOX
CO.1012USB	ENCASTRE ENCHUFE ELEVATOR 1 SCHUKO 2 USB ACABADO INOX

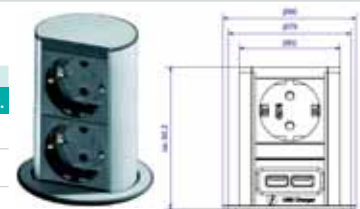

CÓDIGO	DESCRIPCIÓN
D.0710691	ELEVATOR COVER INTERIOR

EMB. 1 UD.



## 10. ILUMINACIÓN Y CONECTIVIDAD

CASIA

EMB. 1 UD.

CÓDIGO	DESCRIPCIÓN
D.0710887	REGLETA UNIVERSAL 4 SCHUCKO ALUMINIO Y NEGRO ALTO 457-585

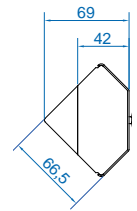

V-DOCK

EMB. 1 UD.

CÓDIGO	DESCRIPCIÓN
D.0710187	V-DOCK 3 SCHUCKO ALUM. Y NEGRO ALTO 66 ANCHO 211 F. 66



BLACK FLIP

EMB. 1 UD.

CÓDIGO	DESCRIPCIÓN
D.0701089	BLACK FLIP 2 SCHUKO+2 USB ALTO 553 ANCHO 226 F. 105,5 ENCASTRE 207*94,5 INOX

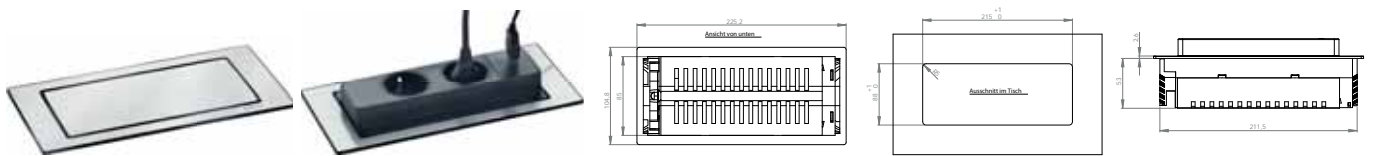

POWER FRAME

EMB. 1 UD.

CÓDIGO	DESCRIPCIÓN
D.0703787	POWER FRAME 2 SCHUKO+2 USB ALTO 45 ANCHO 256 F. 87 ENCASTRE 225*60 ALUMINIO

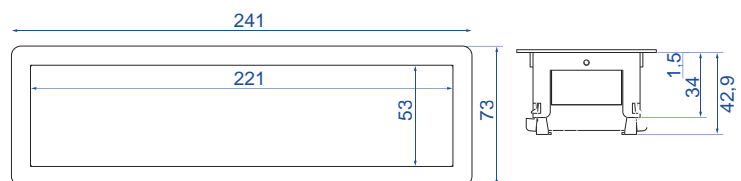

BLOCK

EMB. 1 UD.

CÓDIGO	DESCRIPCIÓN
D.0743620	BLOCK 1 SCHUCKO/1 INTERRUPTOR ALTO 64 ANCHO 140 F.50 GRIS

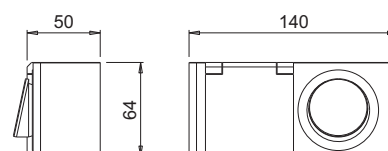

## 10. ILUMINACIÓN Y CONECTIVIDAD



### TIRAS LED

EMB. 1 UD.

CÓDIGO	DESCRIPCIÓN
D.0811601	TIRA LED 5000 MM 48 W NATURAL PUNTOS LEDS 600
D.0811401	TIRA LED 5000 MM 48 W CALIDA PUNTOS LEDS 600
D.0811701	CABLE ALIMENTACION 2000 MM
D.0811901	CABLE EMPALME 50 MM
D.0813501	GRAPA
D.0703001	TRANSFORMADOR 15W-24 VDC
D.0703101	TRANSFORMADOR 30W-24 VDC
D.0707101	TRANSFORMADOR 60W-24 VDC



### SENSOR PRESENCIA

EMB. 1 UD.

CÓDIGO	DESCRIPCIÓN
D.0702701	SENSOR INFRARROJOS IFR V09 POTENCIA 150-250W BLANCO



### SENSOR PROXIMIDAD

EMB. 1 UD.

CÓDIGO	DESCRIPCIÓN
D.0701207	SENSOR SIMPLY R1 POTENCIA 150W NEGRO

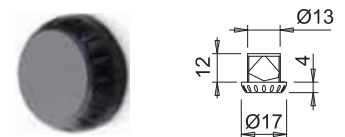

### INTERRUPTOR CLIK

EMB. 1 UD.

CÓDIGO	DESCRIPCIÓN
D.0704201	INTERRUPTOR CLICK BLANCO



### SENSOR OCULTO

EMB. 1 UD.

CÓDIGO	DESCRIPCIÓN
D.0702801	SENSOR OCULTO CAPSENS 30-60 W NEGRO

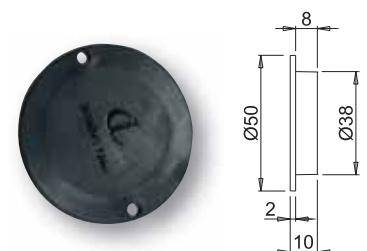

## 10. ILUMINACIÓN Y CONECTIVIDAD

### SENSOR PUERTA Y PROXIMIDAD

EMB. 1 UD.

CÓDIGO	DESCRIPCIÓN
D.0702601	SENSOR INFRARROJOS IR 12/24 FW 15-30W BLANCO

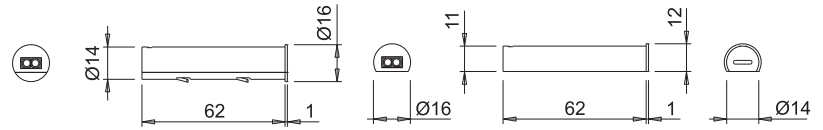

### SENSOR TÁCTIL

EMB. 1 UD.

CÓDIGO	DESCRIPCIÓN
D.0710687	SENSOR TOUCH DOTTI 36/72 W ALUMINIO

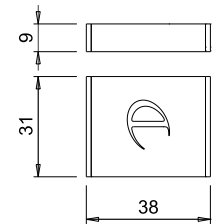

## TRANSFORMADORES

### TRANSFORMADOR 15W

EMB. 1 UD.

CÓDIGO	DESCRIPCIÓN
D.0703001	TRANSFORMADOR 15W-24Vdc BLANCO

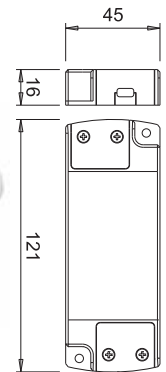

### TRANSFORMADOR 30W

EMB. 1 UD.

CÓDIGO	DESCRIPCIÓN
D.0703101	TRANSFORMADOR 30W-24Vdc BLANCO

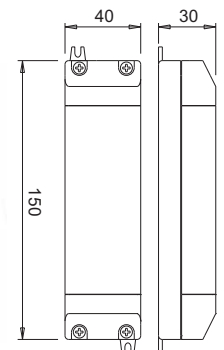

### TRANSFORMADOR 60W

EMB. 1 UD.

CÓDIGO	DESCRIPCIÓN
D.0707101	TRANSFORMADOR 60W-24Vdc BLANCO

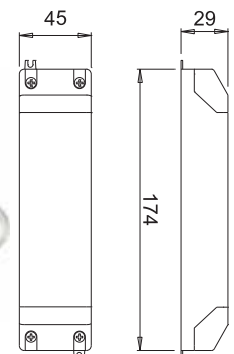



## 10. ILUMINACIÓN Y CONECTIVIDAD

### FOCO ATOM

EMB. 1 UD.

CÓDIGO	DESCRIPCIÓN
D.0712287	FOCO ATOM 3W CROMO MATE Ø57MM
D.0700407	FOCO ATOM 3W NEGRO MATE Ø57MM
D.0810190	FOCO ATOM 3W INOX Ø57MM
D.0702287	SPACE RECTO ATOM CROMO MATE
D.0700507	SPACE RECTO ATOM NEGRO MATE
D.0810290	SPACE RECTO ATOM INOX
D.0702387	SPACE OBLICUO ATOM CROMO MATE
D.0700607	SPACE OBLICUO ATOM NEGRO MATE
D.0810390	SPACE OBLICUO ATOM INOX
CO.1002D	KIT TRANSFORMADOR 24V/15W
CO.1002A	KIT TRANSFORMADOR 24 V/ 30 W
CO.1002B	KIT TRANSFORMADOR 24 V/ 60 W



### FOCO ATOM



Cromo Mate



Negro Mate



Inox

### SPACER RECTO ATOM



Cromo Mate



Negro Mate



Inox

### SPACER OBLICUO ATOM



Cromo Mate



Negro Mate



Inox

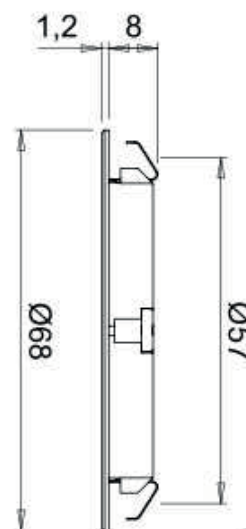

## 10. ILUMINACIÓN Y CONECTIVIDAD

### UNIKA D-MOTION

EMB. 1 UD.

CÓDIGO	DESCRIPCIÓN
D.0810690	UNIKA D-MOTION SLAVE 5W Ø75 ALTURA 64 INOX
D.0810790	UNIKA D-MOTION TDM 5W Ø75 ALTURA 64 INOX
D.0810890	UNIKA D-MOTION SHUCKO 5W Ø75 ALTURA 64 INOX
D.0810990	UNIKA D-MOTION USB 5W Ø75 ALTURA 64 INOX
D.0814107	UNIKA D-MOTION SLAVE 5W Ø75 ALTURA 64 NEGRO MATE
D.0814207	UNIKA D-MOTION TDM 5W Ø75 ALTURA 64 NEGRO MATE
D.0814307	UNIKA D-MOTION SHUCKO 5W Ø75 ALTURA 64 NEGRO MATE
D.0814407	UNIKA D-MOTION USB 5W Ø75 ALTURA 64 NEGRO MATE
CO.1002D	KIT TRANSFORMADOR 24V/15W
CO.1002A	KIT TRANSFORMADOR 24 V/ 30 W
CO.1002B	KIT TRANSFORMADOR 24 V/ 60 W



Unika D-Motion Slave

Unika D-Motion TDM

Unika D-Motion Schuko

Unika D-Motion USB

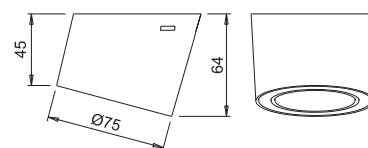
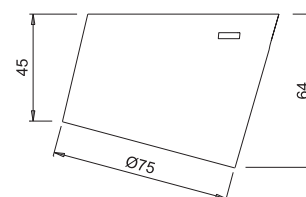
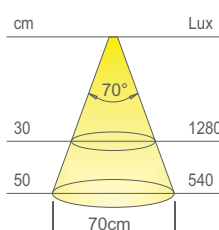
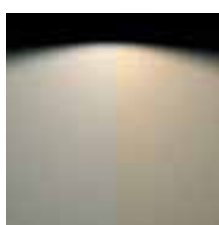

## 10. ILUMINACIÓN Y CONECTIVIDAD



### POLAR SE SLAVE

EMB. 1 UD.

CÓDIGO	DESCRIPCIÓN
D.0712787	POLAR SE SLAVE 5W CROMO MATE
D.0700707	POLAR SE SLAVE 5W NEGRO MATE
CO.1002D	KIT TRANSFORMADOR 24V/15W
CO.1002A	KIT TRANSFORMADOR 24 V/ 30 W
CO.1002B	KIT TRANSFORMADOR 24 V/ 60 W

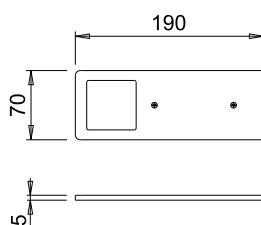

### POLAR SE SDM

EMB. 1 UD.

CÓDIGO	DESCRIPCIÓN
D.0712887	POLAR SE SDM 5W CROMO MATE
D.0700907	POLAR SE SDM 5W NEGRO MATE
CO.1002D	KIT TRANSFORMADOR 24V/15W
CO.1002A	KIT TRANSFORMADOR 24 V/ 30 W
CO.1002B	KIT TRANSFORMADOR 24 V/ 60 W

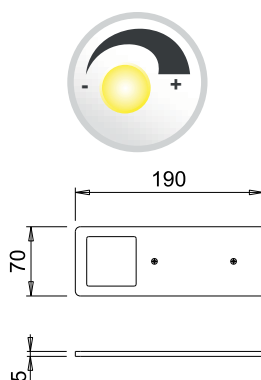

## 10. ILUMINACIÓN Y CONECTIVIDAD

### PERFILES

#### PERFIL EMBUTIR

EMB. 1 UD.

CÓDIGO	DESCRIPCIÓN
HF.83372845	PERFIL EMBUTIR PROFUNDIDAD 6,5 MM ALUMINIO 2500 MM

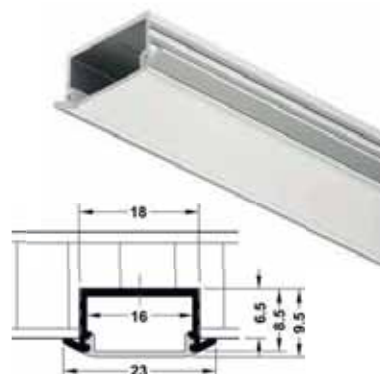

#### PERFIL SUPERFICIE

EMB. 1 UD.

CÓDIGO	DESCRIPCIÓN
HF.83372840	PERFIL SUPERFICIE ALTURA 8,5 MM ALUMINIO 2500 MM



#### PERFIL ANGULAR

EMB. 1 UD.

CÓDIGO	DESCRIPCIÓN
HF.83374815	PERFIL ANGULAR ANCHO 20MM ALTO 20MM ALUMINIO 2500MM

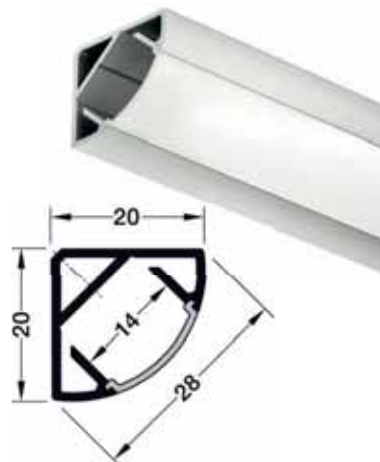

#### PERFIL NEGRO

EMB. 1 UD.

CÓDIGO	DESCRIPCIÓN
CA.17PS002NE	PERFIL NEGRO + DIFUSOR NEGRO ALUMINIO 2500 MM. ANCHO 15MM.



## 10. ILUMINACIÓN Y CONECTIVIDAD

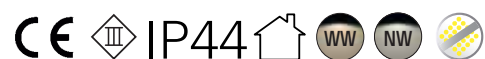

FLEXYLED AT6

EMB. 1 UD.

CÓDIGO	DESCRIPCIÓN
D.0810101	FLEXYLED AT6 20 W LONGITUD 2000 MM ENCASTRE 6 MM LUZ NATURAL
D.0810201	FLEXYLED AT6 30 W LONGITUD 3000 MM ENCASTRE 6 MM LUZ NATURAL
D.0810301	FLEXYLED AT6 20 W LONGITUD 2000 MM ENCASTRE 6 MM LUZ CÁLIDA
D.0810401	FLEXYLED AT6 30 W LONGITUD 3000 MM ENCASTRE 6 MM LUZ CÁLIDA
CO.1002D	KIT TRANSFORMADOR 24V/15W
CO.1002A	KIT TRANSFORMADOR 24 V/ 30 W
CO.1002B	KIT TRANSFORMADOR 24 V/ 60 W



### MODULARIDAD

Doble opción de instalación

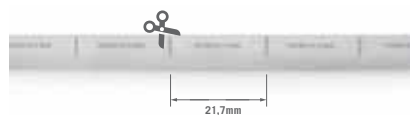

(1) base adhesiva de alta fijación **3M**



(2) fijación mediante clip atornillado

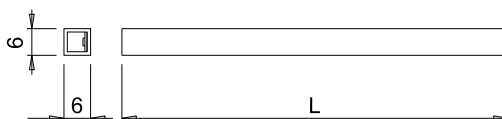

## 11. INTERIORISMO DE ARMARIO

### PANTALONERO SIMPLE

EMB. 1 UD.

CÓDIGO	DESCRIPCIÓN
CO.110150	PANTALONERO 11 BARRAS EXT. TOTAL M-50



### PANTALONERO DOBLE

EMB. 1 UD.

CÓDIGO	DESCRIPCIÓN
CO.110250	PANTALONERO DOBLE EXT. TOTAL FONDO 47



### PANTALONERO CON GOMA

EMB. 1 UD.

CÓDIGO	DESCRIPCIÓN
CO.110310	PANTALONERO 22 BARRAS EXT. TOTAL M-50



### COLGADOR SELF

EMB. 1 UD.

CÓDIGO	DESCRIPCIÓN
E.6210925	COLGADOR SELF 300 CR/AL MET
E.6210825	COLGADOR SELF 350 CR/AL MET
E.6210725	COLGADOR SELF 400 CR/AL MET
E.6210625	COLGADOR SELF 450 CR/AL MET



### CORBATERO

EMB. 1 UD.

CÓDIGO	DESCRIPCIÓN
CO.110602	CORBATERO - CINTURONERO EXTRAÍBLE FONDO 45



### ZAPATERO

EMB. 1 UD.

CÓDIGO	DESCRIPCIÓN
CO.110603	ZAPATERO EXTENSIBLE 80-110



### PANTALONERO EXTRAÍBLE

EMB. 1 UD.

CÓDIGO	DESCRIPCIÓN
CO.110701	PANTALONERO EXTRAÍBLE FONDO 45



### ZAPATERO

EMB. 1 UD.

CÓDIGO	DESCRIPCIÓN
CO.110850	ZAPATERO EXTENSIBLE EXT. TOTAL 46-80
CO.110860	ZAPATERO EXTENSIBLE EXT. TOTAL 56-100



## 11. INTERIORISMO DE ARMARIO

### TOLVAS

EMB. 1 UD.

CÓDIGO	DESCRIPCIÓN
CO.111030	TOLVA ROPA EXT. TOTAL FONDO 47 M-30 CON FRENO
CO.111040	TOLVA ROPA EXT. TOTAL FONDO 47 M-40 CON FRENO
CO.111045	TOLVA ROPA EXT. TOTAL FONDO 47 M-45 CON FRENO
CO.111060	TOLVA ROPA EXT. TOTAL FONDO 47 M-60 CON FRENO
CO.111030A	TOLVA ROPA ABATIBLE FONDO 30 M-30
CO.111035A	TOLVA ROPA ABATIBLE FONDO 30 M-35
CO.111040A	TOLVA ROPA ABATIBLE FONDO 30 M-40
CO.1110045A	TOLVA ROPA ABATIBLE FONDO 30 M-45
CO.1110050A	TOLVA ROPA ABATIBLE FONDO 30 M-50
CO.1110060A	TOLVA ROPA ABATIBLE FONDO 30 M-60



### BARRA ABATIBLE

EMB. 1 UD.

CÓDIGO	DESCRIPCIÓN
CO.111240	BARRA DE COLGAR ABATIBLE 40-60
CO.111260	BARRA DE COLGAR ABATIBLE 60-83
CO.111283	BARRA DE COLGAR ABATIBLE 83-115



### TUBO OVALADO

CÓDIGO	DESCRIPCIÓN	EMB.
CO.111301	TUBO OVALADO PARA ARMARIO TIRAS 4 METROS	20 UDS.
CO.111301A	TUBO OVALADO PARA ARMARIO CURVO 100*10	10 UDS.

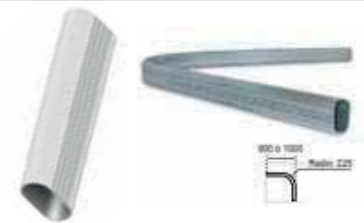

### SOPORTE LATERAL

EMB. 150 UDS.

CÓDIGO	DESCRIPCIÓN
CO.111302	SOPORTE LATERAL PARA TUBO DE ARMARIO



### SOPORTE CENTRAL

EMB. 100 UDS.

CÓDIGO	DESCRIPCIÓN
CO.111303	SOPORTE CENTRAL PARA TUBO DE ARMARIO



### TUBO SILK

CÓDIGO	DESCRIPCIÓN	EMB.
E.6072062	TUBO OVALADO MODELO SILK CON GOMA	10 UDS.
E.6002925	SOPORTE LATERAL DCHO. SILK2 ALUMINIO MATE	1 UD.
E.6003025	SOPORTE LATERAL IZQ. SILK2 ALUMINIO MATE	1 UD.
E.6003125	SOPORTE CENTRAL SILK2 ALUMINIO MATE	1 UD.
E.6003225	SOPORTE ANGULAR SILK2 ALUMINIO MATE	1 UD.

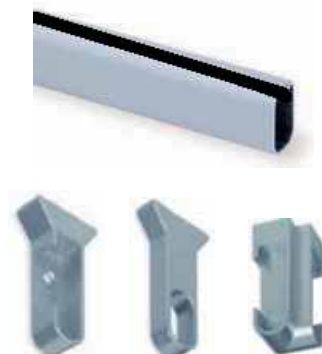

## 11. INTERIORISMO DE ARMARIO

### MESA EXTRAÍBLE

EMB. 1 UD.

CÓDIGO	DESCRIPCIÓN
CO.1111	TABLA PLANCHAR EXTRAÍBLE



### ESPEJO EXTRAÍBLE

EMB. 1 UD.

CÓDIGO	DESCRIPCIÓN
CO.1115E	ESPEJO EXTRAÍBLE Y ORIENTABLE 1200*400 mm



### TABLA PLANCHAR

EMB. 1 UD.

CÓDIGO	DESCRIPCIÓN
D.0526287	TABLA PLANCHAR PRUA LIFT





# INTERIORISMO ANTRACITA



## BARRA ABATIBLE

EMB. 1 UD.

CÓDIGO	DESCRIPCIÓN
D.0912107	SOPORTE PERCHAS ABATIBLES 700/930
D.0912207	SOPORTE PERCHAS ABATIBLES 930/1250



## ESPEJO EXTRAÍBLE

EMB. 1 UD.

CÓDIGO	DESCRIPCIÓN
D.0912307	ESPEJO EXTRAÍBLE GIRATORIO



## BASTIDOR EXTRAÍBLE

EMB. 1 UD.

CÓDIGO	DESCRIPCIÓN
D.0910307	BASTIDOR ARMARIO EXTRAÍBLE C/FRENO ANTRACITA 600 (560-650 MM)
D.0910407	BASTIDOR ARMARIO EXTRAÍBLE C/FRENO ANTRACITA 700 (700-760 MM)
D.0910507	BASTIDOR ARMARIO EXTRAÍBLE C/FRENO ANTRACITA 800 (800-860 MM)
D.0911307	BASTIDOR ARMARIO EXTRAÍBLE C/FRENO ANTRACITA 900 (900-960 MM)



## VARILLA PANTALONERO

EMB. 1 UD.

CÓDIGO	DESCRIPCIÓN
D.0911207	BARRA PANTALONERO BASTIDOR ANTRACITA



## ZAPATERO ANTRACITA

EMB. 1 UD.

CÓDIGO	DESCRIPCIÓN
D.0910607	ZAPATERO BASTIDOR ANTRACITA 600 MM
D.0910707	ZAPATERO BASTIDOR ANTRACITA 700 MM
D.0910807	ZAPATERO BASTIDOR ANTRACITA 800 MM
D.0911407	ZAPATERO BASTIDOR ANTRACITA 900 MM



ORGANIZADOR

EMB. 1 UD.

CÓDIGO	DESCRIPCIÓN
D.0910907	ORGANIZADOR BASTIDOR VACÍA BOLSILLOS ANTRACITA 600 MM
D.0911007	ORGANIZADOR BASTIDOR VACÍA BOLSILLOS ANTRACITA 700 MM
D.0911107	ORGANIZADOR BASTIDOR VACÍA BOLSILLOS ANTRACITA 800 MM
D.0911507	ORGANIZADOR BASTIDOR VACÍA BOLSILLOS ANTRACITA 900 MM



CORBATERO

EMB. 1 UD.

CÓDIGO	DESCRIPCIÓN
D.0911707	CORBATERO/CINTURONERO EXTRAIBLE ANTRACITA F-430
D.0911607	SOPORTE PERCHAS EXTRAIBLE ANTRACITA F-430



TUBO Y SOPORTE

CÓDIGO	DESCRIPCIÓN	
D.0911807	BARRA ARMARIO ROYAL ANTRACITA 3M	EMB. 20 UDS.
D.0912007	SOPORTE CENTRAL BARRA ARMARIO ROYAL ANTRACITA	EMB. 250 UDS.
D.0911907	SOPORTE LATERAL BARRA ARMARIO ROYAL ANTRACITA	EMB. 250 UDS.



## SISTEMAS PUERTAS CORREDERAS - SISTEMA TOPLINE XL



### SISTEMA TOPLINE XL SET DE CARROS Y RODADURA 2 PUERTAS **EMB. 1 UD.**

PUERTAS	18-30	22-30	30-40	40-50
GUÍA 17MM	H.9275796	H.9275794	H.9275793	H.9275740
GUÍA 33MM	H.9275788	H.9275790	H.9275792	H.9275739



### SISTEMA TOPLINE XL SET DE CARROS Y RODADURA 3 PUERTAS **EMB. 1 UD.**

PUERTAS	18-30	22-30	30-40	40-50
GUÍA 17MM	H.9275786	H.9275785	H.9275784	H.9275782
GUÍA 33MM	H.9275781	H.9275709	H.9275741	H.9275706

### SISTEMA TOPLINE XL SET DE CARROS Y RODADURA 4 PUERTAS **EMB. 1 UD.**

PUERTAS	18-30	22-30	30-40
GUÍA 17MM	H.9278780	H.9278791	H.9278792

CÓDIGO	DESCRIPCIÓN	EMB. 1 UD.
H.9276735	SET DE AMORTIGUACIÓN CIERRE Y APERTURA 2 PUERTAS 18-35	
H.9276732	SET DE AMORTIGUACIÓN CIERRE Y APERTURA 2 PUERTAS 30-80	
H.9276737	SET DE AMORTIGUACIÓN CIERRE Y APERTURA 2 PUERTAS 60-100	
H.9276645	SET DE AMORTIGUACIÓN CIERRE Y APERTURA 3 PUERTAS 18-35	
H.9276643	SET DE AMORTIGUACIÓN CIERRE Y APERTURA 3 PUERTAS 30-80	
H.9276646	SET DE AMORTIGUACIÓN CIERRE Y APERTURA 3 PUERTAS 60-100	
H.9278798	SET DE AMORTIGUACIÓN CIERRE Y APERTURA 4 PUERTAS 18-35	
H.9278799	SET DE AMORTIGUACIÓN CIERRE Y APERTURA 4 PUERTAS 30-80	



CÓDIGO	DESCRIPCIÓN	EMB. 1 UD.
H.9278672	SET PERFIL DE RODADURA Y GUÍA L 2300 MM	
H.9278657	SET PERFIL DE RODADURA Y GUÍA L 4000 MM	



## SISTEMA PUERTAS PLEGABLES WINGLINE L

SET DE HERRAJE WINGLINE L 25 KG. CIERRE AUTOMATICO **EMB. 1 UD.**

CÓDIGO	DESCRIPCIÓN
H.9237852	WINGLINE SET 25 KG IZO BIS. CON FRENO
H.9237890	WINGLINE SET 25 KG DERECHA BIS. CON FRENO

FRENO WINGLINE L PULL TO MOVE **EMB. 1 UD.**

CÓDIGO	DESCRIPCIÓN
H.9238120	WINGLINE FRENO TO MOVE IZQ LIGERO
H.9238119	WINGLINE FRENO TO MOVE DCH LIGERO
H.9238121	WINGLINE FRENO TO MOVE IZQ MEDIO
H.9238124	WINGLINE FRENO TO MOVE DCH MEDIO
H.9238123	WINGLINE FRENO TO MOVE IZQ FUERTE
H.9238122	WINGLINE FRENO TO MOVE DCH FUERTE

SET DE HERRAJE WINGLINE L 25KG. SIN CIERRE AUTOMÁTICO (PUSH) **EMB. 1 UD.**

CÓDIGO	DESCRIPCIÓN
H.9237880	WINGLINE SET 25 KG IZO BIS. SIN MUELLE
H.9237881	WINGLINE SET 25 KG DCH BIS. SIN MUELLE

PUSH TO MOVE WINGLINE L **EMB. 1 UD.**

CÓDIGO	DESCRIPCIÓN
H.9238102	WINGLINE PUSH TO MOVE IZQ LIGERO
H.9238113	WINGLINE PUSH TO MOVE DCH LIGERO
H.9238051	WINGLINE PUSH TO MOVE IZQ MEDIO
H.9238101	WINGLINE PUSH TO MOVE DCH MEDIO
H.9238052	WING LINE L PUSH TO MOVE IZQ FUERZA FUERTE
H.9238053	WING LINE L PUSH TO MOVE DCH FUERZA FUERTE

SET PERFILES WINGLINE L **EMB. 1 UD.**

CÓDIGO	DESCRIPCIÓN
H.9239311	SET WINGLINE PERFIL L1200 MM ALU ANO
H.9239310	WINGLINE L SET PERFILES L 2400 MM ALU ANO



## 11. INTERIORISMO DE ARMARIO

### SISTEMAS MODULARES

#### ESTRUCTURAS

CÓDIGO	DESCRIPCIÓN
CO.1119	ESTRUCTURA MODULAR A MEDIDA INOX CONSULTAR PRECIO SEGÚN MEDIDAS Y COLOR



#### SISTEMA MODULAR

CÓDIGO	DESCRIPCIÓN
E.702	ESTRUCTURA MODULAR TO INFINITY CONSULTAR SEGÚN MEDIDAS

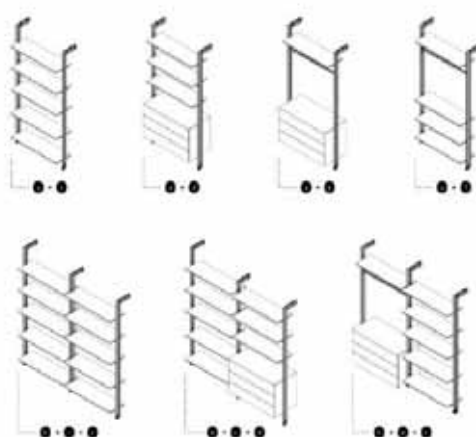

#### TETRIS

CÓDIGO	DESCRIPCIÓN
D.0502307	KIT TETRIS 450
D.0502407	KIT TETRIS 600
D.0502507	KIT TETRIS 900
D.0502607	KIT ANGULOS 4 VIAS
D.0502707	KIT ANGULOS 5 VIAS
D.0502907	KIT SOPORTE 8/10/12/14/16
D.0502807	KIT SOPORTE CRISTAL



**Kit Ángulo 4 Vias**  
Consta de 4 piezas

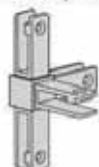

**Kit Ángulo 5 Vias**  
Consta de 2 piezas



**Kit Soporte Tablero**

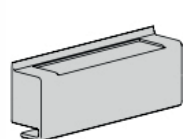

**Kit Soporte Cristal**

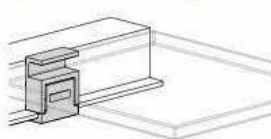

**Kit Tetris 450 / 600 / 900**

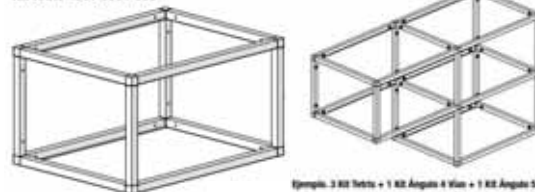

Ejemplo: 3 Kit Tetris + 1 Kit Ángulo 4 Vias + 1 Kit Ángulo 5 Vias

## 12. ARMARIOS

### CARRIL ALTO

EMB. 5 UDS.

CÓDIGO	DESCRIPCIÓN
O.510103602	CARRIL ALTO CAA75 PLATA TIRAS DE 5 METROS ANCHO 75MM* ALTO 40MM.
	OTROS ACABADOS CONSULTAR



### CARRIL BAJO

EMB. 5 UDS.

CÓDIGO	DESCRIPCIÓN
O.510508602	CARRIL BAJO 75 DIENTES CBD75 PLATA TIRAS DE 5 METROS ANCHO 75MM*ALTO 10MM.
	OTROS ACABADOS CONSULTAR

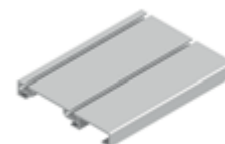

### PERFIL REMATE

EMB. 16 UDS.

CÓDIGO	DESCRIPCIÓN
O.510403602	PERFIL REMATE "U" 16MM PRU16 PLATA TIRAS DE 5 METROS
O.510106602	PERFIL REMATE "U" 10MM PRU10 PLATA TIRAS DE 5 METROS
	OTROS ACABADOS CONSULTAR



### PERFIL H

EMB. 10 UDS.

CÓDIGO	DESCRIPCIÓN
O.510306602	PERFIL REMATE "H" 16MM PRH16 PLATA TIRAS DE 4 METROS
O.510305602	PERFIL REMATE "H" 10MM PRH10 PLATA TIRAS DE 4 METROS
	OTROS ACABADOS CONSULTAR



### KIT DE GUÍAS

EMB. 1 UD.

CÓDIGO	DESCRIPCIÓN
O.545200201	KIT GUÍAS KG75 ALUMINIO LACADO BLANCO A 2 METROS
O.545200602	KIT GUÍAS KG75 ALUMINIO PLATA MATE A 2 METROS
O.545200809	KIT GUÍAS KG75 CHAPA SIN BARNIZAR PINO A 2 METROS
O.545200812	KIT GUÍAS KG75 CHAPA SIN BARNIZAR HAYA VAPORIZADA A 2 METROS
O.545200844	KIT GUÍAS KG75 PAPEL MELAMINA PINO A 2 METROS
O.545200848	KIT GUÍAS KG75 PAPEL MELAMINA HAYA VAPORIZADA A 2 METROS
O.545200843	KIT GUÍAS KG75 PAPEL MELAMINA SAPELLY A 2 METROS
O.545200851	KIT GUÍAS KG75 PAPEL MELAMINA CEREZO TAJO A 2 METROS
O.545200852	KIT GUÍAS KG75 PAPEL MELAMINA WENGUE A 2 METROS
	OTROS ACABADOS Y MEDIDAS CONSULTAR



## 12. ARMARIOS

### KIT DE GUÍAS

EMB. 1 UD.

CÓDIGO	DESCRIPCIÓN
O.545300201	KIT GUÍAS KG75 ALUMINIO LACADO BLANCO A 3 METROS
O.545300602	KIT GUÍAS KG75 ALUMINIO PLATA A 3 METROS
O.545300809	KIT GUÍAS KG75 CHAPA SIN BARNIZAR PINO A 3 METROS
O.545300812	KIT GUÍAS KG75 CHAPA SIN BARNIZAR HAYA VAPORIZADA A 3 METROS
O.545300844	KIT GUÍAS KG75 PAPEL MELAMINA PINO A 3 METROS
O.545300848	KIT GUÍAS KG75 PAPEL MELAMINA HAYA VAPORIZADA A 3 METROS
O.545300843	KIT GUÍAS KG75 PAPEL MELAMINA SAPELLY A 3 METROS
O.545300851	KIT GUÍAS KG75 PAPEL MELAMINA CEREZO TAJO A 3 METROS
O.545300852	KIT GUÍAS KG75 PAPEL MELAMINA WENGUE A 3 METROS
O.545500201	KIT GUÍAS KG75 ALUMINIO LACADO BLANCO A 5 METROS
O.545500602	KIT GUÍAS KG75 ALUMINIO PLATA A 5 METROS
	OTROS ACABADOS Y MEDIDAS CONSULTAR



### KIT DE PUERTA 16 MM.

EMB. 1 UD.

CÓDIGO	DESCRIPCIÓN
O.541002201	KIT PUERTA KP-TR16 LACADO BLANCO A 2,60m + 2m DE "U"
O.541002602	KIT PUERTA KP-TR16 PLATA MATE A 2,60m + 2m DE "U"
O.541002809	KIT PUERTA KP-TR16 CHAPA SIN BARNIZAR PINO A 2,60m + 2m DE "U"
O.541002807	KIT PUERTA KP-TR16 CHAPA SIN BARNIZAR HAYA VAPORIZADA A 2,60m + 2m DE "U"
O.541002844	KIT PUERTA KP-TR16 PAPEL MELAMINA PINO A 2,60m + 2m DE "U"
O.541002848	KIT PUERTA KP-TR16 PAPEL MELAMINA HAYA VAPORIZADA A 2,60m + 2m DE "U"
O.541002843	KIT PUERTA KP-TR16 PAPEL MELAMINA SAPELLY A 2,60m + 2m DE "U"
O.541002851	KIT PUERTA KP-TR16 PAPEL MELAMINA CEREZO TAJO A 2,60m + 2m DE "U"
O.541002852	KIT PUERTA KP-TR16 PAPEL MELAMINA WENGUE A 2,60m + 2m DE "U"
	OTROS ACABADOS Y MODELOS CONSULTAR

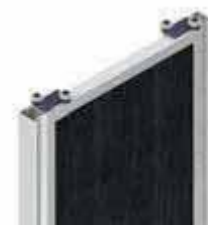

### KIT DE PUERTA 10 MM.

EMB. 1 UD.

CÓDIGO	DESCRIPCIÓN
O.541020201	KIT PUERTA KP-TR10 LACADO BLANCO A 2,60m + 2m DE "U"
O.541020602	KIT PUERTA KP-TR10 PLATA MATE A 2,60m + 2m DE "U"
O.541020809	KIT PUERTA KP-TR10 CHAPA SIN BARNIZAR PINO A 2,60m + 2m DE "U"
O.541020807	KIT PUERTA KP-TR10 CHAPA SIN BARNIZAR HAYA VAPORIZADA A 2,60m + 2m DE "U"
O.541020844	KIT PUERTA KP-TR10 PAPEL MELAMINA PINO A 2,60m + 2m DE "U"
O.541020848	KIT PUERTA KP-TR10 PAPEL MELAMINA HAYA VAPORIZADA A 2,60m.
O.541020843	KIT PUERTA KP-TR10 PAPEL MELAMINA SAPELLY A 2,60m + 2m DE "U"
O.541020851	KIT PUERTA KP-TR10 PAPEL MELAMINA CEREZO TAJO A 2,60m + 2m
O.541020852	KIT PUERTA KP-TR10 PAPEL MELAMINA WENGUE A 2,60m + 2m DE "U"
	OTROS ACABADOS Y MODELOS CONSULTAR



### JUEGO FRENO

EMB. 2 UDS.

CÓDIGO	DESCRIPCIÓN
E.6108320	JUEGO FRENO ARMARIO 30 KG.
E.6108420	JUEGO FRENO ARMARIO 30 KG.



## 12. ARMARIOS

### FRENO CARRIL ALTO

EMB. 50 UDS.

CÓDIGO	DESCRIPCIÓN
O.510007002	FRENO CARRIL ALTO



### FRENO CARRIL BAJO

EMB. 50 UDS.

CÓDIGO	DESCRIPCIÓN
O.510007001	FRENO CARRIL BAJO



### ANCLAJE

EMB. 50 UDS.

CÓDIGO	DESCRIPCIÓN
O.510030001	HERRAJES ANCLAJE CARRIL BAJO



### RUEDAS

EMB. 50 UDS.

CÓDIGO	DESCRIPCIÓN
O.510400060	CONJUNTO RUEDA C/DIENTE DIAM.60 "S.75"



### FELPUDO

EMB. 300 MTS.

CÓDIGO	DESCRIPCIÓN
O.510010653	CEPILLO NEGRO DE 12MM



### BURLETE GOMA

EMB. 100 MTS.

CÓDIGO	DESCRIPCIÓN
O.510011651	PERFIL PVC LATERAL TRANSPARENTE



### GOMA TR10

EMB. 100 MTS.

CÓDIGO	DESCRIPCIÓN
O.510008651	GOMA TR10 CRISTAL 4MM TRANSPARENTE



### GOMA TR16

EMB. 100 MTS.

CÓDIGO	DESCRIPCIÓN
O.510012651	GOMA TR16 CRISTAL 4/5MM TRANSPARENTE





# TIRADORES



# TIRADORES



## 13. TIRADORES

### TIRADORES GAMA ECO

CÓDIGO	DESCRIPCIÓN	EMB. 25 UDS.
CO.13E2304	TIRADOR MOD. 2304 CROMO MATE DE 128MM	



CÓDIGO	DESCRIPCIÓN	EMB. 25 UDS.
CO.13E2418	TIRADOR MOD. 2418 CROMO MATE DE 160MM	
CO.13E2418N	TIRADOR MOD. 2418 NÍQUEL SATINADO DE 160MM	



CÓDIGO	DESCRIPCIÓN	EMB. 25 UDS.
CO.13E2465168	TIRADOR MOD. 2465 NÍQUEL SATINADO DE 160MM	
CO.13E2465228	TIRADOR MOD. 2465 NÍQUEL SATINADO DE 224MM	



CÓDIGO	DESCRIPCIÓN	EMB. 25 UDS.
CO.13E3706	TIRADOR MOD. 370 CROMO MATE DE 160/192MM	
CO.13E3708	TIRADOR MOD. 370 NÍQUEL SATINADO DE 160MM	



CÓDIGO	DESCRIPCIÓN	EMB. 25 UDS.
CO.13E4741A	TIRADOR MOD. 4741 CROMO MATE DE 160 MM	



CÓDIGO	DESCRIPCIÓN	EMB. 25 UDS.
CO.13E4742A	TIRADOR MOD. 4742 NÍQUEL SATINADO DE 128MM/160MM	



CÓDIGO	DESCRIPCIÓN	EMB. 25 UDS.
CO.13E4744	TIRADOR MOD. 4744 CROMO MATE DE 160MM	



CÓDIGO	DESCRIPCIÓN	EMB. 25 UDS.
CO.13E4755	TIRADOR MOD. 4755 CROMO MATE DE 128MM	



## 13. TIRADORES

### TIRADORES GAMA ECO

CÓDIGO	DESCRIPCIÓN	EMB. 25 UDS.
CO.13E4771	TIRADOR MOD. 4771 ALUMINIO ANODIZADO DE 192MM	
CO.13E477132	TIRADOR MOD. 4771 ALUMINIO ANODIZADO DE 320MM	



CÓDIGO	DESCRIPCIÓN	EMB. 25 UDS.
CO.13E477219	TIRADOR MOD. 4772 INOX DE 192MM	
CO.13E477225	TIRADOR MOD. 4772 INOX DE 256MM	



CÓDIGO	DESCRIPCIÓN	EMB. 25 UDS.
CO.13E35178	POMO MOD. 3517 NÍQUEL MATE DE 34MM	
CO.13E35176	POMO MOD. 3517 CROMO MATE DE 34MM	



CÓDIGO	DESCRIPCIÓN	EMB. 25 UDS.
CO.13E4773168	TIRADOR MOD. 4773 NÍQUEL SATINADO DE 160MM	
CO.13E4773256	TIRADOR MOD. 4773 NÍQUEL SATINADO DE 256MM	



CÓDIGO	DESCRIPCIÓN	EMB. 25 UDS.
CO.13E2426	TIRADOR MOD. 2426 CROMO MATE DE 128MM	



CÓDIGO	DESCRIPCIÓN	EMB. 25 UDS.
CO.13E2576162	TIRADOR MOD. 2576 CROMO BRILLO DE 160MM	
CO.13E2576166	TIRADOR MOD. 2576 CROMO MATE DE 160MM	
CO.13E2576168	TIRADOR MOD. 2576 NÍQUEL SATINADO DE 160MM	



CÓDIGO	DESCRIPCIÓN	EMB. 25 UDS.
CO.13E2576252	TIRADOR MOD. 2576 CROMO BRILLO DE 256MM	
CO.13E2576256	TIRADOR MOD. 2576 CROMO MATE DE 256MM	
CO.13E2576258	TIRADOR MOD. 2576 NÍQUEL SATINADO DE 256MM	



## 13. TIRADORES

### TIRADORES GAMA ECO

CÓDIGO	DESCRIPCIÓN	EMB. 10 UDS.
D.090287	PERFIL COLUMBA 2600MM CROMO MATE	

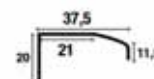

CÓDIGO	DESCRIPCIÓN	EMB. 25 UDS.
D.0132787	ASA 1210 ADHESIVO 150MM ALUMINIO	



CÓDIGO	DESCRIPCIÓN	EMB. 25 UDS.
D.0892987	ASA 1211 70 MM ALUMINIO	
D.0893087	ASA 1211 145 MM ALUMINIO	



CÓDIGO	DESCRIPCIÓN	EMB. 25 UDS.
D.0804407	ASA 1212 145 NEGRO MATE	
D.0804507	ASA 1212 295 NEGRO MATE	
D.0804607	ASA 1212 595 NEGRO MATE	
	DISPONIBLE ACABADO ALUMINIO	

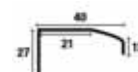

## 13. TIRADORES

### TIRADORES GAMA MEDIA

CÓDIGO	DESCRIPCIÓN	EMB. 25 UDS.
ES.7531021	TIRADOR MOD. 7531 ALUMINIO DE 160MM	
ES.7531038	TIRADOR MOD. 7531 INOX DE 160MM	



CÓDIGO	DESCRIPCIÓN	EMB. 25 UDS.
ES.6752038	TIRADOR MOD. 6752 NÍQUEL CEPILLADO DE 224MM	
ES.7751038	TIRADOR MOD. 7751 NÍQUEL CEPILLADO DE 160M	

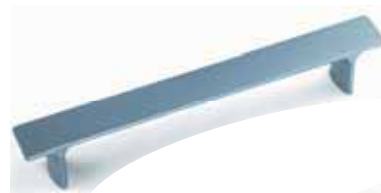

CÓDIGO	DESCRIPCIÓN	EMB. 25 UDS.
ES.7191500	TIRADOR MOD. 7191 NÍQUEL SATINADO DE 128MM	
ES.7192500	TIRADOR MOD. 7192 NÍQUEL SATINADO DE 96MM	
ES.7191836	TIRADOR MOD. 7191 ESTAÑO RÚSTICO DE 128MM	

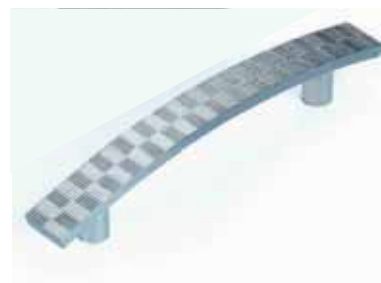

CÓDIGO	DESCRIPCIÓN	EMB. 25 UDS.
ES.8192500	POMO MOD. 8192 NÍQUEL SATINADO DE 30MM	

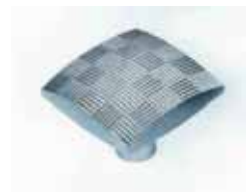

CÓDIGO	DESCRIPCIÓN	EMB. 25 UDS.
ES.7491500	TIRADOR MOD. 7491 NÍQUEL SATINADO DE 128MM	
ES.7491836	TIRADOR MOD. 7491 ESTAÑO RÚSTICO DE 128 MM	

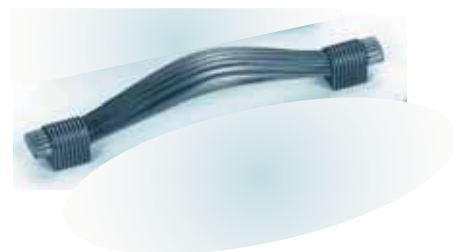

CÓDIGO	DESCRIPCIÓN	EMB. 25 UDS.
ES.8491500	POMO MOD. 8491 NÍQUEL SATINADO DE 30MM	



## 13. TIRADORES

### TIRADORES GAMA MEDIA

CÓDIGO	DESCRIPCIÓN	EMB. 25 UDS.
ES.3701038	TIRADOR EMBUTIDO 3701 NÍQUEL CEPILLADO 50*145MM	



CÓDIGO	DESCRIPCIÓN	EMB. 25 UDS.
ES.6751038	TIRADOR MOD. 6751 NÍQUEL CEPILLADO DE 288 MM	
ES.6752038	TIRADOR MOD. 6752 NÍQUEL CEPILLADO DE 224 MM	



CÓDIGO	DESCRIPCIÓN	EMB. 25 UDS.
ES.6521825	TIRADOR MOD. 6521 ESTAÑO CEPILLADO DE 96 MM	
ES.6521831	TIRADOR MOD. 6521 BRONCE RÚSTICO DE 96 MM	
ES.8521825	POMO MOD. 825 ESTAÑO CEPILLADO DE 36 MM	
ES.8521831	POMO MOD. 8521 BRONCE RÚSTICO DE 36 MM	



CÓDIGO	DESCRIPCIÓN	EMB. 25 UDS.
ES.6160831	POMO MOD. 6160 BRONCE RÚSTICO DE 64 MM	
ES.6160836	POMO MOD. 6160 ESTAÑO RÚSTICO DE 64 MM	
ES.6160400	POMO MOD. 6160 CROMO BRILLO DE 64 MM	
ES.6161831	TIRADOR MOD. 6161 BRONCE RÚSTICO DE 128 MM	
ES.6161836	TIRADOR MOD. 6161 ESTAÑO RÚSTICO DE 128 MM	
ES.6161400	TIRADOR MOD. 6161 CROMO BRILLO DE 128 MM	



CÓDIGO	DESCRIPCIÓN	EMB. 25 UDS.
ES.3281038	TIRADOR MOD. 3281 NÍQUEL CEPILLADO DE 90*50 MM	
ES.3282038	TIRADOR MOD. 3282 NÍQUEL CEPILLADO DE 42*74 MM	



## 13. TIRADORES

### TIRADORES GAMA MEDIA

CÓDIGO	DESCRIPCIÓN	EMB. 25 UDS.
ES.6831038	TIRADOR MOD. 6831 NÍQUEL SATINADO DE 192 MM	
ES.6832038	TIRADOR MOD. 6832 NÍQUEL SATINADO DE 128 MM	
	DISPONIBLES EN DIFERENTES ACABADOS	



CÓDIGO	DESCRIPCIÓN	EMB. 25 UDS.
ES.8102038	POMO MOD. 8102 NÍQUEL SATINADO DE 50*50	
ES.8103038	POMO MOD. 8103 NÍQUEL CEPILLADO DE 32*32 MM	
	DISPONIBLES EN DIFERENTES ACABADOS	





## 13. TIRADORES

### TIRADORES GAMA MEDIA

CÓDIGO	DESCRIPCIÓN	EMB. 25 UDS.
ES.7241038	TIRADOR MOD. 7241 NÍQUEL CEPILLADO DE 192 MM	
ES.7242038	TIRADOR MOD. 7242 NÍQUEL CEPILLADO DE 160 MM	
	DISPONIBLES EN DIFERENTES ACABADOS	



CÓDIGO	DESCRIPCIÓN	EMB. 25 UDS.
ES.3560038	TIRADOR EMBUTIDO MOD. 3560 NÍQUEL CEPILLADO 50*50 MM	
ES.3561038	TIRADOR EMBUTIDO MOD. 3561 NÍQUEL CEPILLADO 39*39	
ES.3562038	TIRADOR EMBUTIDO MOD. 3561 NÍQUEL CEPILLADO 29*29	
	DISPONIBLES EN DIFERENTES ACABADOS	



CÓDIGO	DESCRIPCIÓN	EMB. 25 UDS.
ES.7150038	TIRADOR MOD. 7150 NÍQUEL CEPILLADO DE 96 MM.	
	DISPONIBLES EN DIFERENTES ACABADOS	



CÓDIGO	DESCRIPCIÓN	EMB. 25 UDS.
ES.9700836	TIRADOR MOD. 9700 ESTAÑO RÚSTICO DE 96 MM.	
	DISPONIBLES EN DIFERENTES ACABADOS	



CÓDIGO	DESCRIPCIÓN	EMB. 25 UDS.
ES.9841831	TIRADOR MOD. 9841 BRONCE RÚSTICO Y PORCELANA MARFIL DEC DE 128 MM	
	DISPONIBLES EN DIFERENTES ACABADOS	



## 13. TIRADORES

### TIRADORES GAMA MEDIA

CÓDIGO	DESCRIPCIÓN	EMB. 25 UDS.
ES.6190811	POMO MOD. 6190 BRONCE INDUSTRIAL DE 49*24 MM.	
ES.6190812	POMO MOD. 6190 HIERRO INDUSTRIAL DE 49*24 MM.	



CÓDIGO	DESCRIPCIÓN	EMB. 25 UDS.
ES.6191811	TIRADOR MOD. 6191 BRONCE INDUSTRIAL DE 160 MM.	
ES.6191812	TIRADOR MOD. 6191 HIERRO INDUSTRIAL DE 160 MM.	



CÓDIGO	DESCRIPCIÓN	EMB. 25 UDS.
ES.6211811	TIRADOR MOD. 6211 BRONCE INDUSTRIAL DE 160 MM.	
ES.6211812	TIRADOR MOD. 6211 HIERRO INDUSTRIAL DE 160 MM.	



CÓDIGO	DESCRIPCIÓN	EMB. 25 UDS.
ES.1801800	TIRADOR MOD. 1801 CROMO MATE DE 288/320 MM.	
ES.1801038	TIRADOR MOD. 1801 NÍQUEL CEPILLADO DE 288/320 MM.	
ES.1802800	TIRADOR MOD. 1802 CROMO MATE DE 192/224 MM.	
ES.1802038	TIRADOR MOD. 1802 NÍQUEL CEPILLADO DE 192/224 MM.	
ES.1803800	TIRADOR MOD. 1803 CROMO MATE DE 128/160 MM.	
ES.1803038	TIRADOR MOD. 1803 NÍQUEL CEPILLADO DE 128/160 MM.	



## 13. TIRADORES

### TIRADORES GAMA MEDIA

CÓDIGO	DESCRIPCIÓN	EMB. 25 UDS.
ES.1810800	TIRADOR MOD. 1810 CROMO MATE DE 192/224 MM.	
ES.1810038	TIRADOR MOD. 1810 NÍQUEL CEPILLADO DE 192/224 MM.	



CÓDIGO	DESCRIPCIÓN	EMB. 25 UDS.
ES.1820800	TIRADOR MOD. 1820 CROMO MATE DE 192/224 MM.	
ES.1820038	TIRADOR MOD. 1820 NÍQUEL CEPILLADO DE 192/224 MM.	



CÓDIGO	DESCRIPCIÓN	EMB. 25 UDS.
ES.1830800	TIRADOR MOD. 1830 CROMO MATE DE 192/224 MM.	
ES.1830038	TIRADOR MOD. 1830 NÍQUEL CEPILLADO DE 192/224 MM.	



CÓDIGO	DESCRIPCIÓN	EMB. 25 UDS.
ES.8151020	POMO MOD. 8151 ORO CEPILLADO DE 25*25 MM.	
ES.8152038	POMO MOD. 8152 NÍQUEL SATINADO DE 15*15 MM.	
	DISPONIBLES EN COLORES: ALUMINIO, NÍQUEL CEPILLADO, CROMO BRILLO, CROMO MATE, ORO MATE, GRAFITO Y ORO CEPILLADO	



CÓDIGO	DESCRIPCIÓN	EMB. 25 UDS.
ES.8161292	POMO MOD. 8161 BLANCO MATE DE 25 MM.	
ES.8162292	POMO MOD. 8162 BLANCO MATE DE 15 MM.	
	DISPONIBLES EN COLORES: ALUMINIO, NÍQUEL CEPILLADO, CROMO BRILLO, CROMO MATE, ORO MATE, GRAFITO, ORO CEPILLADO, BLANCO Y NEGRO	



## 13. TIRADORES

### TIRADORES GAMA MEDIA

CÓDIGO	DESCRIPCIÓN	EMB. 25 UDS.
ES.6821292	TIRADOR MOD. 6821 BLANCO MATE DE 320 MM.	
ES.6822292	TIRADOR MOD. 6822 BLANCO MATE DE 224 MM.	
	DISPONIBLES EN COLORES: NÍQUEL CEPILLADO, CROMO BRILLO, CROMO MATE, ORO MATE, GRAFITO, ORO CEPILLADO, BLANCO Y NEGRO	



CÓDIGO	DESCRIPCIÓN	EMB. 25 UDS.
ES.6811292	TIRADOR MOD. 6811 BLANCO MATE DE 224 MM.	
ES.6812292	TIRADOR MOD. 6812 BLANCO MATE DE 160 MM.	
	DISPONIBLES EN COLORES: NÍQUEL CEPILLADO, CROMO BRILLO, CROMO MATE, ORO MATE, GRAFITO, ORO CEPILLADO, BLANCO Y NEGRO	



CÓDIGO	DESCRIPCIÓN	EMB. 25 UDS.
ES.6781292	TIRADOR MOD. 6781 BLANCO MATE DE 224 MM.	
ES.6782292	TIRADOR MOD. 6782 BLANCO MATE DE 160 MM.	
	DISPONIBLES EN COLORES: NÍQUEL CEPILLADO, CROMO BRILLO, CROMO MATE, BLANCO Y NEGRO	

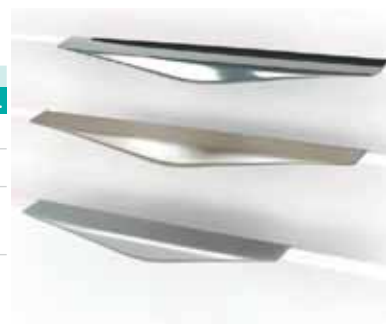

CÓDIGO	DESCRIPCIÓN	EMB. 25 UDS.
ES.6791292	TIRADOR MOD. 6791 BLANCO MATE DE 192 MM.	
ES.6792292	TIRADOR MOD. 6792 BLANCO MATE DE 128 MM.	
	DISPONIBLES EN COLORES: NÍQUEL CEPILLADO, CROMO MATE, BLANCO Y NEGRO	

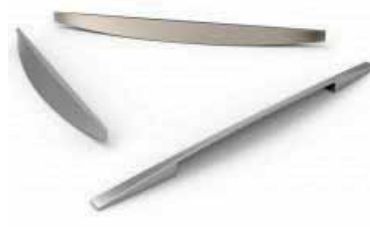

## 13. TIRADORES

### TIRADORES GAMA MEDIA

CÓDIGO	DESCRIPCIÓN	EMB. 25 UDS.
ES.6761292	TIRADOR MOD. 6761 BLANCO MATE DE 320 MM.	
ES.6762292	TIRADOR MOD. 6762 BLANCO MATE DE 256 MM.	
ES.6763292	TIRADOR MOD. 6763 BLANCO MATE DE 192 MM.	
ES.6764292	TIRADOR MOD. 6764 BLANCO MATE DE 160 MM.	
ES.6765292	TIRADOR MOD. 6765 BLANCO MATE DE 128 MM.	
	DISPONIBLES EN COLORES: NÍQUEL CEPILLADO, CROMO MATE, ORO MATE, GRAFITO Y ORO CEPILLADO	



CÓDIGO	DESCRIPCIÓN	EMB. 25 UDS.
ES.6231292	TIRADOR MOD. 6231 BLANCO MATE DE 192 MM.	
ES.6232292	TIRADOR MOD. 6232 BLANCO MATE DE 128 MM.	
	DISPONIBLES EN COLORES: NÍQUEL CEPILLADO, BLANCO MATE Y NEGRO MATE	



CÓDIGO	DESCRIPCIÓN	EMB. 25 UDS.
ES.7150800	TIRADOR MOD. 7150 CROMO MATE DE 96 MM.	
	DISPONIBLES EN COLORES: ALUMINIO, NÍQUEL CEPILLADO, NÍQUEL SATINADO, CROMO BRILLO, CROMO MATE, ORO MATE, GRAFITO Y ORO CEPILLADO	



CÓDIGO	DESCRIPCIÓN	EMB. 25 UDS.
ES.9821831	TIRADOR MOD. 9821 BRONCE RUSTICO Y PORCELANA CRAQUELADA A 128 MM.	
ES.9822831	TIRADOR MOD. 9821 BRONCE RUSTICO Y PORCELANA CRAQUELADA A 96 MM.	
	DISPONIBLES EN COLORES: CRAQUELE/BRONCE RÚSTICO Y CRAQUELE/LATÓN CEPILLADO	



## 13. TIRADORES

### TIRADORES GAMA PREMIUM

CÓDIGO	DESCRIPCIÓN	EMB. 25 UDS.
VI.0230064Z23	ASA 2300 NÍQUEL CEPILLADO 64 MM	
VI.0230160Z23	ASA 2301 NÍQUEL CEPILLADO 160 MM	



CÓDIGO	DESCRIPCIÓN	EMB. 25 UDS.
VI.0112160Z23	ASA 1121 NÍQUEL CEPILLADO 160 MM	



CÓDIGO	DESCRIPCIÓN	EMB. 25 UDS.
VI.0117128L24	ASA 1171 INOXIDABLE LOOK 128 MM	
VI.0117192L24	ASA 1171 INOXIDABLE LOOK 192 MM	



CÓDIGO	DESCRIPCIÓN	EMB. 25 UDS.
VI.0241192Z01	ASA 2411 CROMO BRILLO 192 MM	
VI.0241192Z23	ASA 2411 NÍQUEL CEPILLADO 192 MM	



CÓDIGO	DESCRIPCIÓN	EMB. 25 UDS.
VI.0195192L24	ASA 1951 INOXIDABLE LOOK 192MM	
VI.0195320L24	ASA 1951 INOXIDABLE LOOK 320MM	



CÓDIGO	DESCRIPCIÓN	EMB. 25 UDS.
VI.0206192Z01	ASA 2061 CROMO BRILLO 192 MM	
VI.0206192Z23	ASA 2061 NÍQUEL CEPILLADO 192 MM	



## 13. TIRADORES

### TIRADORES GAMA D

CÓDIGO	DESCRIPCIÓN	EMB. 25 UDS.
CO.13D89196	TIRADOR DE BARRA DE 96MM DE TORNILLO A TORNILLO	
CO.13D891128	TIRADOR DE BARRA DE 128MM DE TORNILLO A TORNILLO	
CO.13D891160	TIRADOR DE BARRA DE 160MM DE TORNILLO A TORNILLO	
CO.13D891192	TIRADOR DE BARRA DE 192MM DE TORNILLO A TORNILLO	
CO.13D891256	TIRADOR DE BARRA DE 242MM DE TORNILLO A TORNILLO	
CO.13D891306	TIRADOR DE BARRA DE 292MM DE TORNILLO A TORNILLO	
CO.13D891356	TIRADOR DE BARRA DE 342MM DE TORNILLO A TORNILLO	
CO.13D891430	TIRADOR DE BARRA DE 392MM DE TORNILLO A TORNILLO	
CO.13D891456	TIRADOR DE BARRA DE 492MM DE TORNILLO A TORNILLO	
CO.13D891575	TIRADOR DE BARRA DE 592MM DE TORNILLO A TORNILLO	
CO.13D891632	TIRADOR DE BARRA DE 692MM DE TORNILLO A TORNILLO	
CO.13D891758	TIRADOR DE BARRA DE 792MM DE TORNILLO A TORNILLO	
CO.13D891840	TIRADOR DE BARRA DE 892MM DE TORNILLO A TORNILLO	
CO.13D8911105	TIRADOR DE BARRA DE 992MM DE TORNILLO A TORNILLO	



### PERFIL GOLA

CÓDIGO	DESCRIPCIÓN
D.0842487	GOLA HORIZONTAL LATERAL ALUMINIO 4 ML "J"
D.0842487A	GOLA HORIZONTAL LATERAL ANTRACITA 4 ML "J"
D.0842401	GOLA HORIZONTAL LATERAL BLANCO 4 ML "J"
D.0842401M	GOLA HORIZONTAL LATERAL BLANCO MATE 4 ML "J"
D.0842487CO	GOLA HORIZONTAL LATERAL CASTORO OTAWA 4 ML "J"
D.0842487X	GOLA HORIZONTAL LATERAL INOX 4 ML "J"
D.0842401N	GOLA HORIZONTAL LATERAL NEGRO 4 ML "J"
D.0842490	GOLA HORIZONTAL LATERAL TITANIO 4 ML "J"
D.0842401A	GOLA HORIZONTAL LATERAL BLANCO ALSKA 4 ML "J"



CÓDIGO	DESCRIPCIÓN
D.0842287	GOLA HORIZONTAL CENTRAL ALUMINIO 4 ML "U"
D.0842287A	GOLA HORIZONTAL CENTRAL ANTRACITA 4 ML "U"
D.0842201	GOLA HORIZONTAL CENTRAL BLANCO 4 ML "U"
D.0842201M	GOLA HORIZONTAL CENTRAL BLANCO MATE 4 ML "U"
D.0842287CO	GOLA HORIZONTAL CENTRAL CASTORO OTAWA 4 ML "U"
D.0842287X	GOLA HORIZONTAL CENTRAL INOX 4 ML "U"
D.0842201N	GOLA HORIZONTAL CENTRAL NEGRO 4 ML "U"
D.0842201A	GOLA HORIZONTAL CENTRAL BLANCO ALSKA 4 ML "U"



## 13. TIRADORES

### PERFIL GOLA

#### PERFIL MUEBLE ALTO

CÓDIGO	DESCRIPCIÓN
D.0842G	GOLA MUEBLE ALTO CON GOMA ALUMINIO 3,0 ML
D.0842G-A	GOLA MUEBLE ALTO CON GOMA ANTRACITA 3,0 ML
D.084201G	GOLA MUEBLE ALTO CON GOMA BLANCO 3,0 ML
D.084201GM	GOLA MUEBLE ALTO CON GOMA BLANCO MATE 3,0 ML
D.0842GX	GOLA MUEBLE ALTO CON GOMA INOX MATE 3,0 ML
D.084203G	GOLA MUEBLE ALTO CON GOMA NEGRO 3,0 ML
D.0842G-19	GOLA MUEBLE ALTO CON GOMA ALUMINIO 3,0 ML PARA 19
D.0842G-A19	GOLA MUEBLE ALTO CON GOMA ANTRACITA 3,0 ML PARA 19
D.0842201G19	GOLA MUEBLE ALTO CON GOMA BLANCO 3,0 ML PARA 19
D.0842G-19N	GOLA MUEBLE ALTO CON GOMA NEGRO 3,0 ML PARA 19



#### TAPAS

CÓDIGO	DESCRIPCIÓN
D.0842887	TAPA GOLA LATERAL DERECHA ALUMINIO
D.0842887A	TAPA GOLA LATERAL DERECHA ANTRACITA
D.0842801	TAPA GOLA LATERAL DERECHA BLANCO
D.0842887CO	TAPA GOLA LATERAL DERECHA CASTORO OTAWA
D.0842887X	TAPA GOLA LATERAL DERECHA INOX
D.0842887N	TAPA GOLA LATERAL DERECHA NEGRA



CÓDIGO	DESCRIPCIÓN
D.0842987	TAPA GOLA LATERAL IZQUIERDA ALUMINIO
D.0842987A	TAPA GOLA LATERAL IZQUIERDA ANTRACITA
D.0842901	TAPA GOLA LATERAL IZQUIERDA BLANCO
D.0842987CO	TAPA GOLA LATERAL IZQUIERDA CASTRO OTAWA
D.0842987X	TAPA GOLA LATERAL IZQUIERDA INOX
D.0842987N	TAPA GOLA LATERAL IZQUIERDA NEGRA



CÓDIGO	DESCRIPCIÓN
D.0616987	TAPA GOLA CENTRAL ALUMINIO
D.0616987A	TAPA GOLA CENTRAL ANTRACITA
D.0616901	TAPA GOLA CENTRAL BLANCO
D.0616987CO	TAPA GOLA CENTRAL CASTORO OTAWA
D.0616987X	TAPA GOLA CENTRAL INOX
D.0616987N	TAPA GOLA CENTRAL NEGRA



#### PERFIL VERTICAL

CÓDIGO	DESCRIPCIÓN
D.0616087	GOLA ABIERTA VERTICAL MEDIA ALUMINIO 4 ML
D.0616087A	GOLA ABIERTA VERTICAL MEDIA ANTRACITA 4 ML
D.0616001	GOLA ABIERTA VERTICAL MEDIA BLANCA 4 ML
D.0616001M	GOLA ABIERTA VERTICAL MEDIA BLANCA MATE 4 ML
D.0616001N	GOLA ABIERTA VERTICAL MEDIA NEGRA 4 ML
D.0616087X	GOLA ABIERTA VERTICAL MEDIA INOX 4 ML



#### PERFIL VERTICAL LATERAL

CÓDIGO	DESCRIPCIÓN
D.0616187	GOLA ABIERTA VERTICAL LATERAL ALUMINIO 4 ML
D.0616187A	GOLA ABIERTA VERTICAL LATERAL ANTRACITA 4 ML
D.0616401	GOLA ABIERTA VERTICAL LATERAL BLANCA 4 ML
D.0616401M	GOLA ABIERTA VERTICAL LATERAL BLANCA MATE 4 ML
D.0616401N	GOLA ABIERTA VERTICAL LATERAL NEGRA 4 ML
D.0616187X	GOLA ABIERTA VERTICAL LATERAL INOX 4 ML





## 13. TIRADORES

### PERFIL GOLA

#### ACCESORIOS

CÓDIGO	DESCRIPCIÓN
D.0842287E	ESQUINA GOLA "J" PLATA MATE
D.0842201NE	ESQUINA GOLA "J" NEGRO
D.0842201X	ESQUINA GOLA "J" INOX
D.0842201E	ESQUINA GOLA "J" BLANCO
D.0842201CO	ESQUINA GOLA "J" CASTORO OTAWA
D.0842201A	ESQUINA GOLA "J" ANTRACITA



#### RINCÓN GOLA

CÓDIGO	DESCRIPCIÓN
D.0842487R	RINCÓN GOLA "J" PLATA MATE
D.0842487NR	RINCÓN GOLA "J" NEGRO
D.0842401X	RINCÓN GOLA "J" INOX
D.0842401R	RINCÓN GOLA "J" BLANCO
D.0842401CO	RINCÓN GOLA "J" CASTORO OTAWA
D.0842401RA	RINCÓN GOLA "J" ANTRACIA



#### FIJACIÓN GOLA

CÓDIGO	DESCRIPCIÓN
D.06M	JUEGO FIJACIÓN GOLA METÁLICO
D.06ME	JUEGO FIJACIÓN GOLA METÁLICA ESCUADRA



#### FALSO GOLA

CÓDIGO	DESCRIPCIÓN
JE.43C103101300	TIRADOR L UÑERO 30°19 +1 PLATA MATE A 3 METROS DISPONIBLES PLATA BRILLO



CÓDIGO	DESCRIPCIÓN
JE.43C1191013	TIRADOR UÑERO DE 21 MM LARGO 3 METROS PLATA MATE DISPONIBLES PLATA BRILLO



CÓDIGO	DESCRIPCIÓN
JE.43C1151013	TIRADOR UÑERO FALSO GOLA CROMO MATE TIRA DE 3 MTS DISPONIBLES PLATA BRILLO, BLANCO MATE Y BRILLO, INOX Y NEGRO MATE



## 14. ACCESORIOS ESPECIALES

### BISAGRA AIR

EMB. 1 JUEGO

CÓDIGO	DESCRIPCIÓN
D.0264293	SET BISAGRA AIR CON FRENO NIQUEL ANCHO MAX PTA 600 MM ALTO MAX PTA 2100 MM PESO MAX 20KG. EMBALJE 20KG.
D.0200407	SET BISAGRA AIR CON FRENO TITANIO ANCHO MAX PTA 600 MM ALTO MAX PTA 2100 MM PESO MAX 20KG. EMBALJE 20KG.
	Espesor mínimo costado 18 mm.



Set Bisagra Air Titanio

### SPACE FLEXX

EMB. 1 UD.

CÓDIGO	DESCRIPCIÓN
D.0317320	SPACE FLEXX ANCHO 520 ALTO 130 FONDO 472 CROMO/GRIS



### GUÍA SHELF (EXTRACCIÓN TOTAL)

EMB. 1 JUEGO

CÓDIGO	DESCRIPCIÓN
D.0302768	JUEGO GUIA SHELF CON FRENO FONDO 400
D.0302868	JUEGO GUIA SHELF CON FRENO FONDO 450
D.0302968	JUEGO GUIA SHELF CON FRENO FONDO 500
D.0303068	JUEGO GUIA SHELF PUSH FONDO 400
D.0303168	JUEGO GUIA SHELF PUSH FONDO 450
D.0303268	JUEGO GUIA SHELF PUSH FONDO 500
D.0320020	SET MANETA DE FIJACION 3D
D.0303368	RETENEDOR GUIA SHELF
	La Guía Shelf, está certificada por LGA para 50.000 ciclos de apertura con una capacidad de carga de 30 Kg. Posibilidad de instalar 2 juegos de guías para aumentar capacidad de carga y ancho de la bandeja extraíble.



## 14. ACCESORIOS ESPECIALES

### EASY

EMB. 1 UD.

CÓDIGO	DESCRIPCIÓN
H.9210848	EASY PARA FRIGORIFICOS, INC. CABLE DE RED TIPO C
	Se puede adaptar a puerta lavavajillas.



### COLUMNA ELEVABLE LEGAMOVE

EMB. 1 UD.

CÓDIGO	DESCRIPCIÓN
H.9225570	COLUMNA DE ELEVACION LEGAMOVE ALUMINIO

- Sistema de columnas electromotriz para el descenso vertical y la elevación de armarios con paredes colgantes
  - Columna telescópica doble con secuencia de movimiento sincronizado
  - Altura de la columna 736 mm - 1225 mm
  - Longitud de carrera 489 mm (limitada electrónicamente)
  - Columna 90 x 90 mm
  - Fuerza máxima de elevación 40 kg
  - Velocidad de ajuste 32 mm/s
  - Longitud de cable aprox. 1400 mm
- Tecnología de accionamiento completamente integrada en la columna



### IMOVE

EMB. 1 UD.

CÓDIGO	DESCRIPCIÓN
D.0414920	IMOVE INDIVIDUAL ANCHO 600 ALTO 380 GRIS
D.0415120	IMOVE INDIVIDUAL ANCHO 900 ALTO 380 GRIS
D.0415320	IMOVE DOBLE ANCHO 600 ALTO 565 GRIS



### PORTA COPAS NEGRO

EMB. 1 UD.

CÓDIGO	DESCRIPCIÓN
D.0503307	PORTA COPAS NEGRO ANCHO 480 ALTO 32 FONDO 250



### TOLVA

EMB. 1 UD.

CÓDIGO	DESCRIPCIÓN
D.0510101	CESTA EXTRAIBLE 35+35 L ANCHO MOD. 600 ANCHO 562-568 ALTO 570 FONDO 506 ACABADO BLANCO/AZUL



## 14. ACCESORIOS ESPECIALES

### ELEVA

CÓDIGO	DESCRIPCIÓN
D.0526187	ELEVA 2 PELDAÑOS ANCHO 420 ALTO 450 GROSOR 87



Soporte escalera ELeva



### SOPORTES ACCESORIOS HANG

CÓDIGO	DESCRIPCIÓN
D.0406307	HANG SENCILLO 600 ANCHO 600 ALTO 404 FONDO 50
D.0406407	HANG SENCILLO 900 ANCHO 900 ALTO 404 FONDO 50
D.0406507	HANG DOBLE 600 ANCHO 1200 ALTO 404 FONDO 50
D.0406607	HANG DOBLE 900 ANCHO 1800 ALTO 404 FONDO 50
D.0406707	BALDA HANG 550 ANCHO 550 ALTO 24 FONDO 140
D.0406807	BALDA HANG 850 ANCHO 850 ALTO 24 FONDO 140
D.0406907	PORTARROLLOS HANG ANCHO 285 ALTO 83 FONDO 83
D.0407007	TABLA DE CORTE HANG ANCHO 300 ALTO 204 FONDO 48
D.0407107	PORTACUCHILLOS HANG ANCHO 250 ALTO 204 FONDO 53
D.0407207	SET 3 GANCHOS HANG ANCHO 10 ALTO 30 FONDO 30

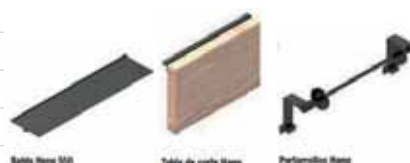

### COPETE GOMA D10

CÓDIGO	DESCRIPCIÓN
D.0600287	COPETE D10 LONGITUD 4000 ALUMINIO
D.0602720	JUEGO TAPAS D10 GRIS



### PERFIL FERMEZZA

CÓDIGO	DESCRIPCIÓN
D.0600487	FERMEZZA 19 MM ALUMINIO ANCHO 18 ALTO 40 L.4000
D.0601202	FERMEZZA 19 MM ANTRACITA ANCHO 18 ALTO 40 L.4000



## 14. ACCESORIOS ESPECIALES

### PERFIL VELVET / CONECTORES

CÓDIGO	DESCRIPCIÓN
D.0900820	CONECTOR 2 VIAS SU MISURA ALTO 60 GROSOR 8 GRIS
D.0900920	CONECTOR 3 VIAS SU MISURA ALTO 60 GROSOR 8 GRIS
D.0901020	CONECTOR 4 VIAS SU MISURA ALTO 60 GROSOR 8 GRIS
D.0901620	CONECTOR 2 VIAS SU MISURA ALTO 90 GROSOR 8 GRIS
D.0901720	CONECTOR 3 VIAS SU MISURA ALTO 90 GROSOR 8 GRIS
D.0901820	CONECTOR 4 VIAS SU MISURA ALTO 90 GROSOR 8 GRIS
D.0901120	PERFIL VELVET SU MISURA ALTO 60 GROSOR 8 L2000 GRIS
D.0901220	PERFIL VELVET SU MISURA ALTO 90 GROSOR 8 L2000 GRIS
D.0901320	PORTA ANILLOS VELVET SU MISURA ANCHO 120 ALTO 50 L100
D.0901420	PORTA ANILLOS VELVET SU MISURA ANCHO 80 ALTO 45 L 70
	<b>Con el Perfil Su Misura en sus dos alturas más sus tres tipologías de conectores, nos permite poder conformar este accesorio a cualquier medida y diseño.</b>



### T-ABLE - MECANISMO MESA EXTRAÍBLE

CÓDIGO	DESCRIPCIÓN
D.0720587	MECANISMO T-ABLE ANCHO 600 ALTO 745-840 ALTO MIN. 120 F.540 INOX/BLANCO
D.0600820	MECANISMO T-ABLE ANCHO 900 ALTO 745-840 ALTO MIN. 120 F.540 INOX/BLANCO
D.0720687	MECANISMO T-ABLE XL ANCHO 600 ALTO 700-795 ALTO MIN. 150 F.520 INOX
D.0720787	MECANISMO T-ABLE XL ANCHO 900 ALTO 700-795 ALTO MIN. 150 F.520 INOX
D.0720887	MECANISMO T-BENCH ANCHO 450 ALTO 385-410 ALTO MIN. 120 F.540 INOX/LANCO
	<b>T-Able y T-Bench se suministrarán con tablero Blanco Soft 16 mm. T-Able XL se suministrará sin tablero. Capacidad de carga máxima 100 Kg.</b>



### COCKTAIL - MECANISMO MESA EXTRAÍBLE

CÓDIGO	DESCRIPCIÓN
D.0610587	COCKTAIL ANCHO 1200 ALTO 120 FONDO 540 INOX
D.0601401	BISAGRAS UNIÓN
	<b>Este artículo se suministrará sin tablero. Posibilidad de adaptar a otras medidas, simplemente cortando la barra. Capacidad de carga máxima 60 Kg.</b>



### LUNCH - MECANISMO MESA EXTRAÍBLE

CÓDIGO	DESCRIPCIÓN
D.0600920	MECANISMO LUNCH ANCHO 900 ALTO MIN. 120 FONDO 540 INOX/BLCO
	<b>Este artículo se suministrará con tablero Blanco Soft 16 mm.. Capacidad de carga máxima 60 Kg.</b>



## 14. ACCESORIOS ESPECIALES

### TOP FLEX - MECANISMO MESA EXTRAÍBLE

CÓDIGO	DESCRIPCIÓN
D.0426620	TOP FLEX ANCHO 450-900 ALTO MIN. 120 FONDO 500 GRIS
	Este artículo se suministrará sin tablero. Capacidad de carga máxima 30 Kg.



### OPLA TOP - MECANISMO MESA EXTRAÍBLE

CÓDIGO	DESCRIPCIÓN
D.0610487	OPLA TOP ANCHO 1200 ALTO 75 FONDO 540 INOX
	Este artículo se suministrará sin tablero. Posibilidad de adaptar a otras medidas, simplemente cortando la barra. Capacidad de carga máxima 40 Kg.



### FUNTIONAL - MECANISMO MESA EXTRAÍBLE

CÓDIGO	DESCRIPCIÓN
D.0700178	FUNTIONAL ANCHO 900 ALTO MIN. 110 FONDO 540 INOX
	Este artículo se suministrará con tablero y cubertero, tal y como aparecen en la fotografía del catálogo. Capacidad de carga máxima 40 Kg.



### SECURA

CÓDIGO	DESCRIPCIÓN
D.0503407	SECURE ANCHO 480 ALTO 150 FONDO 400 NEGRO
	Apertura automática por código de seguridad en panel táctil con alarma. No necesita instalación eléctrica, alimentación por pilas y toma de corriente USB ante posible pérdida de potencia en baterías. Apertura opcional por llave oculta. Posibilidad de panelar para personalizar el frontal y los laterales de la caja para integrar con el resto del mobiliario.



### SOFT MOVE

CÓDIGO	DESCRIPCIÓN
CO.03P	SOFT MOVE PARA PUERTAS DE 4 KG A 7,5 KG.



## 14. ACCESORIOS ESPECIALES

### TOPE DOOR-SOFT

CÓDIGO	DESCRIPCIÓN
D.0700220	TOPE DOOR-SOFT Ø 5 GRIS
D.0700302	TOPE DOOR-SOFT Ø 5 ANTRACITA



### SISTEMA UNIÓN ENCIMERAS

CÓDIGO	DESCRIPCIÓN
D.0733820	SISTEMA UNIÓN ENCIMERAS CINCO/GRIS

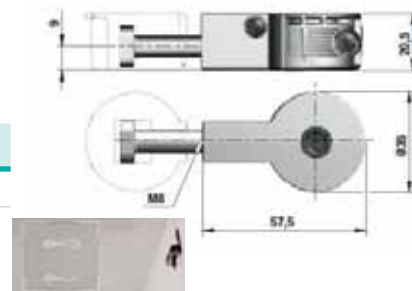

### PASACABLES TAMPA

CÓDIGO	DESCRIPCIÓN
E.5123815	PASACABLE CIRCULAR ENCASTRE 60 DISPONIBLE ENCASTRE 80 Y EN COLORES BLANCO GRIS Y NEGRO

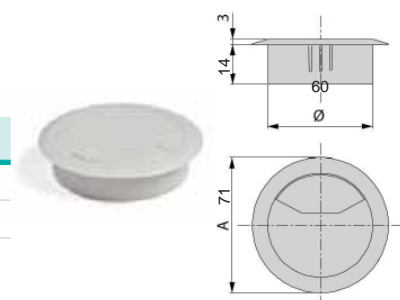

### PASACABLES METAL

CÓDIGO	DESCRIPCIÓN
E.5006711	PASACABLE METAL CIRCULAR ENCASTRE 60 DISPONIBLE ENCASTRE 80 Y EN COLORES CROMO Y CROMO MATE

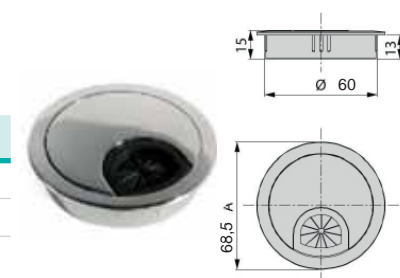

### PASACABLES RECTANGULAR

CÓDIGO	DESCRIPCIÓN
E.5010062	PASACABLE RECTANGULAR 159*80 ALUMINIO MATE EN-CASTRE 147*68 DISPONIBLE MEDIDA 269*257



### PASACABLES CUADRADO

CÓDIGO	DESCRIPCIÓN
E.50112511	PASACABLE CUADRADO 85*85 ENCASTRE 78*78 DISPONIBLE EN COLORES BLANCO , NEGRO Y CROMO PLATA

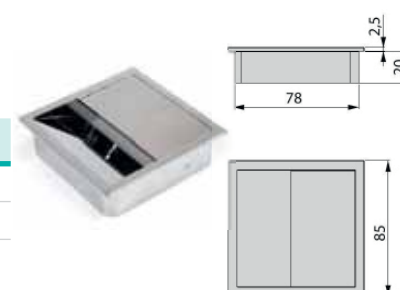



# ESTRUCTURAS DE MESA

## ESTRUCTURAS DE MESA

CÓDIGO	DESCRIPCIÓN
CO.H20	NM-INDUSTRIA H20 710*820-20M a20 Acero NEGRO MATE
CO.H40	NM-INDUSTRIA H40 710*820-20M a40 Acero NEGRO MATE



CÓDIGO	DESCRIPCIÓN
CO.P20	NM-INDUSTRIA P20 710*820-20M a20 Acero NEGRO MATE
CO.P40	NM-INDUSTRIA P40 710*820-20M a40 Acero NEGRO MATE
CO.P80	NM-INDUSTRIA P80 710*820-20M a80 Acero NEGRO MATE



CÓDIGO	DESCRIPCIÓN
CO.T20	NM-INDUSTRIA T20 710*820-20M a20 Acero NEGRO MATE
CO.T40	NM-INDUSTRIA T40 710*820-20M a40 Acero NEGRO MATE



CÓDIGO	DESCRIPCIÓN
CO.X20	NM-INDUSTRIA X20 710*820-20M a20 Acero NEGRO MATE
CO.X40	NM-INDUSTRIA X40 710*820-20M a40 Acero NEGRO MATE
CO.X80	NM-INDUSTRIA X80 710*820-20M a80 Acero NEGRO MATE

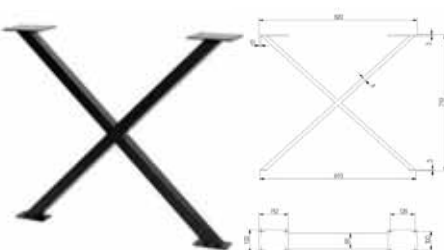



# TORNILLERÍA



CÓDIGO	DESCRIPCIÓN
CO.14013,5*16	TORNILLO ZINCADO 3,5*16 PACK DE 1000 UND
CO.14013,5*20	TORNILLO ZINCADO 3,5*20 PACK DE 1000 UND
CO.14013,5*25	TORNILLO ZINCADO 3,5*25 PACK DE 1000 UND
CO.14013,5*30	TORNILLO ZINCADO 3,5*30 PACK DE 1000 UND
CO.14013,5*35	TORNILLO ZINCADO 3,5*35 PACK DE 1000 UND
CO.14013,5*40	TORNILLO ZINCADO 3,5*40 PACK DE 500 UND
CO.14013,5*45	TORNILLO ZINCADO 3,5*45 PACK DE 500 UND
CO.14013,5*50	TORNILLO ZINCADO 3,5*50 PACK DE 500 UND



CÓDIGO	DESCRIPCIÓN
CO.14014*16	TORNILLO ZINCADO 4*16 PACK DE 1000 UND
CO.14014*20	TORNILLO ZINCADO 4*20 PACK DE 1000 UND
CO.14014*25	TORNILLO ZINCADO 4*25 PACK DE 1000 UND
CO.14014*30	TORNILLO ZINCADO 4*30 PACK DE 1000 UND
CO.14014*35	TORNILLO ZINCADO 4*35 PACK DE 1000 UND
CO.14014*40	TORNILLO ZINCADO 4*40 PACK DE 500 UND
CO.14014*45	TORNILLO ZINCADO 4*45 PACK DE 500 UND
CO.14014*50	TORNILLO ZINCADO 4*50 PACK DE 200 UND
CO.14014*60	TORNILLO ZINCADO 4*60 PACK DE 200 UND



CÓDIGO	DESCRIPCIÓN
CO.14014*20	TORNILLO ZINCADO 4,5*20 PACK DE 1000 UND
CO.14014*25	TORNILLO ZINCADO 4,5*25 PACK DE 1000 UND
CO.14014*30	TORNILLO ZINCADO 4,5*30 PACK DE 1000 UND
CO.14014*35	TORNILLO ZINCADO 4,5*35 PACK DE 1000 UND
CO.14014*40	TORNILLO ZINCADO 4,5*40 PACK DE 500 UND
CO.14014*45	TORNILLO ZINCADO 4,5*45 PACK DE 500 UND
CO.14014*50	TORNILLO ZINCADO 4,5*50 PACK DE 200 UND
CO.14014*60	TORNILLO ZINCADO 4,5*60 PACK DE 200 UND



## ALLEN

CÓDIGO	DESCRIPCIÓN
CO.140100	TORNILLO ALLEN DE ENSAMBLAJE 5*50 PACK DE 3500 UNID.
CO.140100A	TORNILLO ALLEN DE ENSAMBLAJE 5*50 PACK 100 UND.
	OTRAS MEDIDAS Y ACABADOS CONSULTAR



## 15. TORNILLERÍA



### TORNILLO DE TIRADORES

#### TORNILLOS MÉTRICA

CÓDIGO	DESCRIPCIÓN
CO.140201	TORNILLO MÉTRICA M4*22 PACK DE 500 UND.
CO.140202	TORNILLO MÉTRICA M4*25 PACK DE 500 UND.
CO.140208	TORNILLO METRICA MULTICORTE M4*45 PACK DE 500 UND



### PUNTAS PARA ATORNILLAR

#### PUNTAS

CÓDIGO	DESCRIPCIÓN
CO.140301	PUNTA POZI Nº 1
CO.140302	PUNTA POZI Nº 2



### TACOS

#### TACOS

CÓDIGO	DESCRIPCIÓN
CO.140406	TACOS GRIS DE 6MM PACK DE 1000UNID.
CO.140408	TACOS GRIS DE 8MM PACK DE 1000UNID.
CO.140410	TACOS GRIS DE 10MM PACK DE 500UNID.



#### TORNILLO EURO

CÓDIGO	DESCRIPCIÓN
D.0603496	TORNILLO EURO 7,7*12,7 ZINCADO



#### BROCAS

CÓDIGO	DESCRIPCIÓN
CO.H-320	BROCA HSS PARA TORNILLO ENSAMBLE Ø 5



CÓDIGO	DESCRIPCIÓN
CO.H-235	BROCA MD PARA BISAGRAS Ø 35







**HERRAJES TÉCNICOS HTP S.L.**

Polígono Industrial El Manchón

C/ San Roque, 27

41940 **Tomares**

SEVILLA

**670 374 489**

**955 264 915**

*[www.herrajestecnicoshtp.com](http://www.herrajestecnicoshtp.com)*